

**THE CITY OF THORNTON
9500 CIVIC CENTER DRIVE
THORNTON, CO 80229-4326**

**Project Manual
For
Construction of**

ZADEL RESERVOIR FENCING

PROJECT NO. 18-554

JANUARY 2024

THIS PAGE INTENTIONALLY LEFT BLANK

TABLE OF CONTENTS

SECTION TITLE

Table of Contents

Invitation for Bid Proposals

Information for Bidders

Procedure for Contract Signing

Bid Proposal

Contractor's Post-Qualifications

Reference Authorization and Release Form

Post-Qualification Questionnaire

Bidder's Post-Qualification Affidavit

Contract

Addenda

THIS PAGE INTENTIONALLY LEFT BLANK

INVITATION FOR BID PROPOSALS

**City of Thornton
9500 Civic Center Drive
Thornton, CO 80229-4326**

Sealed Bid Proposals for construction of the **Zadel Reservoir Fencing, Project No. 18-554** will be received in the Contract Administration Office at the City of Thornton (Thornton) City Hall (2nd floor), 9500 Civic Center Drive, until **2:00 p.m., Tuesday, February 6, 2024**. At that time, the bid will be publicly opened and read aloud.

Note: Late Proposals will not be accepted under any circumstances. Vendors electing to submit their bid via mail or courier service accept all responsibility for delivery to the Contract Administration Office by the bid closing time indicated. Thornton is not responsible for lost or late delivery of bid proposals.

Project Description: The Project consists of installation 9635 linear feet of seven (7) foot 9 gauge galvanized chain link fence with barbed wire surrounding the Zadel Reservoir at the northwest corner of Weld County Road 18 and Weld County Road 25 and as further described in the Contract Documents.

Thornton utilizes the BidNet Direct System at www.BidNetDirect.com to distribute official copies of the Drawings and Project Manual ("Bid Documents") for use in preparing Bid Proposals. Bidders will be required to register with the website to download the Bid Documents and Addenda. There is no charge by BidNet Direct for this service. If you experience problems with the BidNet Direct website, please call 1-800-835-4603 for assistance. Bidders are required to acknowledge all Addenda with their Bid Proposal and are encouraged to either register with the website or to view the Addenda posted on the Contract Administration Solicitation website: <https://solicitations.thorntonco.gov/solicitations> prior to submission of a Bid Proposal. Bidders that do not acknowledge all Addenda may be considered non-responsive. The Bid Documents, including Addenda, are also available for viewing at the Contract Administration office located on the 2nd floor of City Hall at 9500 Civic Center Drive, Thornton, Colorado. Bidders that do not have download and/or printing capability in-house, may contact a commercial blueprint company or other reprographics company for assistance with downloading and printing the Bid Documents.

An optional Pre-Bid Conference will be held in the **Community Room, at the Infrastructure Maintenance Center at 12450 Washington St., Thornton, CO at 1:00 p.m., Thursday, January 25, 2024**. All Prospective Bidders are encouraged to attend. A Project site walk-through will be conducted following the Pre-Bid Conference.

Each Bid Proposal shall be submitted on form(s) furnished by Thornton and must be accompanied by a certified check, cashier's check, or bid bond in an amount of not less than five percent (5%) of the amount of the Bid Proposal and made payable to the City of Thornton.

The successful Bidder will be required to furnish a Performance Bond and a Labor and Material Payment Bond, each in the amount of one hundred percent (100%) of the total Contract Price, in conformity with the requirements of the Contract Documents.

The successful Bidder will be determined on the basis of the lowest responsive and responsible Bid Proposal. The apparent successful Bidder(s) will be post qualified. Thornton based businesses may be granted consideration in evaluation of Bid Proposals, if they meet the following criteria:

- A. The business maintains an office, manufacturing, training, retail, or repair facility within Thornton city limits;
- B. The business has a current Thornton business license;
- C. The business is current on all Thornton obligations; and
- D. The Bidder requests the consideration on the Bid Proposal Form and supplies the necessary documentation.

All nonmonetary bid criteria being equal, Thornton business' Bid Proposals will be discounted for the purpose of evaluating the Bid Proposal prices when compared to non-Thornton-based businesses by the lesser of five percent (5%) of the Bid Proposal price or ten thousand dollars (\$10,000).

Thornton reserves the right to reject any or all Bid Proposals, to waive any informalities or irregularities in the Bid Proposals received, and to accept the Bid Proposal which in its judgment best serves the interests of Thornton. The apparent successful Bidder will be required to complete a Reference Authorization and Release Form.

All questions shall be directed in writing to Patrick Hinterberger, Contracts Supervisor, 9500 Civic Center Drive, Thornton, CO 80229-4326, fax – 303-538-7556, or e-mail – patrick.hinterberger@thorntonCO.gov, 8:00 a.m. to 5:00 p.m., local time, Monday through Friday, excluding holidays.

Date First Published: January 11, 2024

Published at: BidNet Direct, COT Website and the Contracts & Purchasing Bulletin Board.

BY: 
 Patrick Hinterberger
 Contracts Supervisor

INFORMATION FOR BIDDERS

Thornton may consider non-conforming any Bid Proposal not prepared and submitted in accordance with the provisions hereof and may waive any informalities or reject any and all Bid Proposals.

Bidder may, without prejudice, withdraw a Bid Proposal after it has been deposited with Thornton, provided the request for such withdrawal is received by Thornton, in writing, before the deadline set for submission of Bid Proposals. Telephonic communications withdrawing a Bid Proposal will not be accepted.

Any Bidder may modify its Bid Proposal in writing any time prior to the scheduled deadline for submission of Bid Proposals, provided such modification is received by Thornton prior to the Bid Proposal submission deadline. The modification shall not reveal the Bid Proposal price, but shall provide only the addition or subtraction or other modification so that the final prices or terms will not be known by Thornton until the original sealed Bid Proposal is opened.

Any Bid Proposal received after the time and date deadline specified will not be considered.

After opening of Bid Proposals, a Bid Proposal may not be withdrawn by the Bidder for a period of thirty (30) Calendar Days, or as otherwise required by law. Each Bid Proposal must be accompanied by either a certified check or a cashier's check made payable to The City of Thornton, or a Bid Bond duly executed by the Bidder as principal and having as Surety thereon a Surety company approved by Thornton, in the amount of five percent (5%) of the total Bid Proposal amount. Such checks or Bid Bonds of the three (3) lowest Bidders may be retained by Thornton for a period of thirty (30) Calendar Days after the Bid Proposal opening. Other Bidders' Bid Proposal security will be returned within seven (7) Calendar Days from Thornton's receipt of request.

Each Bid Proposal **must be submitted on the Bid Proposal form(s) provided by Thornton** and must be signed by the Bidder or its duly authorized agent. All blank spaces for Bid Proposal prices must be filled in, in ink or typewritten, **IN BOTH WORDS AND NUMERALS**, where called for in the Bid Proposal.

If there is a discrepancy between the total price in words and the total price in numbers, the total price in words will govern. If there is a discrepancy between the Unit or Lump Sum Prices multiplied by the respective quantities and the extended Bid Proposal Prices for individual Pay Items, the Unit Price or Lump Sum Prices multiplied by the respective quantity shall be the governing number, and the extended price or prices and the resulting Total Price will be adjusted accordingly.

Conditional Bid Proposals will not be accepted.

Each Bid Proposal must be submitted in a sealed envelope bearing on the outside the name of the Bidder, Bidder's address, and the name of the Project and the Project Number for which the Bid Proposal is submitted. If submitted by mail, package delivery, or courier

service, a sealed envelope containing the Bid Proposal must be enclosed in a mailing envelope addressed to the Contracts and Purchasing Director, 9500 Civic Center Drive, 2nd Floor City Hall, Thornton, CO 80229-4326. Please be sure to note on the outside of the mailing envelope "Bid Proposal Enclosed, Zadel Reservoir Fencing, Project No. 18-554".

Simultaneously with the delivery of the executed Bonds, the Contractor shall furnish its IRS W-9 Taxpayer ID Form, the Affidavit if required, the required insurance certificate(s), required endorsements thereto, ACORD Form 101 if required, and Performance and Labor and Material Payment Bonds as security for faithful performance of the Contract and for the payment of all persons performing labor in connection with the Work covered under the Contract and furnishing materials in connection with the Contract, as specified in the Contract Documents. The Surety on such Bonds shall be a duly authorized Surety company satisfactory to Thornton. Attorneys-in-fact who sign Bid Bonds or Performance and Labor and Material Payment Bonds must file with each bond a certified and effectively dated copy of their Power of Attorney. The Surety or Sureties must be listed in Federal Circular 570 and must be approved by Thornton. In no case will Sureties with less than a Best's A rating be approved. Insurers, at a minimum, are required to be admitted in the State of Colorado and maintain an A.M. Best Financial Strength Rating of A or higher.

The successful Bidder, upon Bidder's failure or refusal to execute and deliver the required Contract, Bonds if required, insurance certificate(s), additional insured endorsements, ACORD Form 101 if required, and/or the W-9 Form within ten (10) Calendar Days from and including the date of Notice of Award, shall forfeit to Thornton the security deposited with its Bid Proposal. Notice of Thornton's intent to retain the bid security shall either be hand delivered by Thornton to the Bidder's address, as given on the Bid Proposal form, or mailed to such address, first class, United States mail, return receipt requested. Delivery or mailing of the notice to the address provided shall constitute the required notice without the requirement of an acknowledgment of receipt from the Bidder.

Each Bidder must inform itself fully of the conditions relating to the construction of the Work and the employment of labor thereon. Failure to do so will not relieve a successful Bidder of its obligation to furnish all Materials and Equipment and labor necessary to carry out the requirements of the Contract Documents. Insofar as possible, the Bidder, in carrying out its Work, must employ such methods or means as will not cause any interruption of or interference with the work of any other contractor.

The Bidder's attention is directed to the fact that all applicable state laws, municipal ordinances, and the rules and regulations of all authorities having jurisdiction over construction of the Work shall apply to the Contract throughout, and will be deemed to be included in the Contract the same as though herein written out in full.

No interpretation of the meaning of the Drawings, Specifications, Addenda, other Bid Documents, Contract Documents, or Pre-Bid Meeting Minutes will be made to any Bidder orally. If a Bidder who contemplates submitting a Bid Proposal is in doubt about the precise meaning of any part of the proposed Contract Documents, it may submit to Thornton a written request for an interpretation. Every request for such interpretation shall be in writing addressed to Patrick Hinterberger, Contracts Supervisor, 9500 Civic Center Drive, Thornton, CO 80229-4326, fax – 303-538-7556, or e-mail –

Patrick.hinterberger@thorntonCO.gov and to be given consideration it must be received by 5:00 p.m., on the tenth (10th) Calendar Day prior to the date fixed for the submission of Bid Proposals. The Bidder submitting the request will be responsible for its prompt and actual delivery. Thornton will not be responsible for any other explanations or interpretations of the Contract Documents which anyone may make on behalf of Thornton. Any and all such interpretations and any supplemental instructions will be in the form of written Addenda to the Bid Documents or to the Contract Documents which, if issued, will be posted on BidNet Direct System's website at www.BidNetDirect.com and on the Contract Administration bulletin board later than three (3) Calendar Days prior to the date fixed for submission of Bid Proposals. Failure of any Bidder to receive any such Addenda or interpretation shall not relieve such Bidder from any obligation under its Bid Proposal, as submitted. All Addenda so issued shall become part of the Contract Documents. It shall be the responsibility of each Bidder to verify that each Addendum has been received. A bulletin board will be maintained at the Contract Administration Office which will list the current Projects with Bid Proposal due dates and all Addenda, including the date of issue for each. It is recommended that all Bidders check this board for the status of the particular Project they are interested in bidding prior to submitting a Bid Proposal.

At the time of submission of a Bid Proposal, each Bidder shall have completed a thorough site inspection including, but not limited to, the location, accessibility, and general character of the site of the Work and all existing buildings and structures within and adjacent to the Project site, sufficient to satisfy itself as to the nature of the Work, the condition of existing buildings and structures, the conformation of the ground, the character, quality, and the nature of any Construction Equipment, and any other facilities needed preliminary to and during construction of the Work, the general and local conditions, the construction hazards, and all other matters, including the labor situation, which might affect the Work. The Bidder also will have carefully examined and be thoroughly familiar with the Contract Documents, including all Addenda, and satisfied itself as to the feasibility and correctness of the Contract Documents for the construction of the Work and that it accepts all terms, conditions, and stipulations contained in the Contract Documents, and is prepared to work in peace and harmony with other contractors performing work at the Project site. Bidders also shall have reviewed the insurance requirements contained in the Contract Documents. The failure or omission of any Bidder to examine any form, instrument, or document shall in no way relieve any Bidder from any obligation in respect to its Bid Proposal. The Bidder is to confirm the completeness of the Contract Documents on which its Bid Proposal is based. If the Bidder determines its Contract Documents are incomplete or irregular, it is the Bidder's responsibility to bring this fact to the attention of the Contract Administrator prior to submitting a Bid Proposal.

Thornton invites Bid Proposals on the form(s) included as part of this document to be submitted at such time and place as stated in the Invitation for Bid Proposals. All blanks in the Bid Proposal forms must be appropriately filled in with typewriter or ink. Bidders are instructed to submit the entire Bid Proposal form. **It is the sole responsibility of the Bidder to see that the Bid Proposal is received by Thornton before the scheduled deadline set for submission of Bid Proposals.** Any Bid Proposals received after the scheduled deadline for submission of Bid Proposals will be returned to the Bidder unopened.

The Bid Proposal must be signed in the name of the Bidder and must bear the signature in long hand of the person or persons duly authorized to sign the Bid Proposal. Changes in or additions to the Bid Proposal forms, recapitulations of the Work bid upon, alternative Bid Proposals not requested by Thornton, or any other modifications of the Bid Proposal which are not specifically called for in the Bid Documents, the Contract Documents, or an Addendum may be rejected by Thornton as not being responsive to the solicitation.

Bid Proposals shall be made in the name of the principal, and if a co-partnership, the names of all partners shall be given. Exact postal address shall be given in all cases. If Bid Proposals are submitted by an agent, satisfactory evidence of agency authority must accompany the Bid Proposal. Corporate Bidders, to be eligible to enter into a Contract with Thornton, shall be qualified to do business in the State of Colorado and Thornton. Bidders shall comply with applicable licensing requirements. Firms which have not become licensed in Thornton shall obtain a permit to do business in Thornton pursuant to Thornton's requirements prior to submission of a Bid Proposal.

The Bid Proposal submitted must not contain erasures, corrections, or changes from the printed forms as completed in typewriter or ink, unless such erasures, corrections, or changes are authenticated by affixing in the margin immediately opposite the erasure, correction, or change, the initials of the person who signed the Bid Proposal or the initials of such other person as may be authorized by the Bidder to make erasures, corrections, or changes in the Bid Proposal, and such authorization must be evidenced by written confirmation, executed by the person authorized to sign the initial Bid Proposal, attached to the Bid Proposal at the time of submittal.

Bid Proposals may be considered non-conforming and may be rejected for any of the following reasons, unless otherwise provided by law:

1. If the Bid Proposal form(s) furnished to the Bidder by Thornton is not used or is altered;
 2. If there are unauthorized additions or conditional Bid Proposals, or irregularities of any kind which may tend to make the Bid Proposal incomplete, indefinite, or ambiguous as to its meaning;
 3. If the Bidder adds any provisions reserving the right to accept or reject any Contract award or to enter into a Contract pursuant to an award;
 4. If the Unit Prices or Lump Sum Prices contained in the Bid Proposal are unbalanced either above or below reasonable cost analysis values as determined by Thornton;
 5. If the Bid Proposal Pay Item price for mobilization exceeds ten percent (10%) of the total Contract Price;
 6. If the Bidder fails to insert a price for every Bid Proposal Pay Item indicated;
- or;

7. If the Bidder fails to complete the Bid Proposal in any other particulars where information is requested so Bidder's Proposal may be properly evaluated.

Thornton reserves the right to reject any or all Bid Proposals and to waive irregularities or informalities as may be deemed in Thornton's best interest.

Thornton reserves the right to reject any Bid Proposal if investigation of such Bidder fails to satisfy Thornton that such Bidder is properly qualified to carry out the obligations and to complete the Work contemplated by the Contract Documents. Any or all Bid Proposals will be rejected if there is reason to believe that collusion exists among Bidders.

Thornton reserves the right to prequalify Bidders, to post-qualify Bidders, to reject all Bid Proposals, not to make an award, and/or to accept the Bid Proposal deemed most advantageous and in the best interest of Thornton. The Bidder must comply with all information and instructions for Bidders. The Award of the Contract, if made by Thornton, will be made by written Notice of Award to a qualified, responsible, responsive, and trustworthy Bidder submitting the lowest and best Bid Proposal, but Thornton shall determine in its sole discretion whether a Bidder is responsible, responsive, qualified, and trustworthy to perform the Contract, whether by prequalification, post-qualification, or other methods, and which Bid Proposal is the lowest and best and whether it is in the best interest of Thornton to accept the Bid Proposal. Thornton reserves the right to request financial statements, together with a Bidder's Post Qualification Form, which includes a statement of past experience, personnel resumes, Construction Equipment available to perform the Work, the Bidder's proposed Schedule of Work, and other qualification information, from any Bidder considered for award of a Contract. Failure or refusal to furnish such qualification information, or failure to provide a satisfactory statement of financial responsibility, shall constitute a basis for disqualifying any Bidder. In evaluating whether the Bidder is responsible, Thornton, in its sole discretion, may consider such things as whether the Bidder is in arrears to Thornton under any obligation; has an unacceptable performance or claims history with Thornton or with other owners; is not trustworthy; has submitted false information in the past, or is currently involved in a dispute with Thornton. Thornton also reserves the right to require evidence of satisfactory operation of any Construction Equipment required to be used to perform the Work. Thornton will consider the Bid Proposals and reserves the right to reject any or all Bid Proposals, to pass upon the regularity, or waive any irregularity or informality, of the Bidders and the acceptability of the Surety offered.

Prior to bidding, requests to substitute Materials or Equipment from those specified shall be made in writing and shall identify the Material or Equipment, or the fabrication or installation method to be replaced, in each request and shall include related Specification sections and Drawing numbers. The Bidder shall provide complete documentation showing compliance with the requirements for substitutions, and the following information, as appropriate:

1. Product data, including Drawings and descriptions of products, fabrication and installation procedures;
2. Samples, where applicable or requested;

3. A detailed comparison of significant qualities of the proposed substitution with those of the Work specified. Significant qualities may include elements such as size, weight, durability, performance, and visual effect;
4. Coordination information, including a list of changes or modifications needed to other parts of the Work and to construction performed by Thornton and separate contractors, which will become necessary to accommodate the proposed substitution;
5. Any additional information Thornton may request.

All requests for substitution shall be submitted in writing to the Contract Administrator, and all such requests shall be received by Thornton no later than 5:00 p.m., on the tenth (10th) Calendar Day prior to the Bid Proposal submittal date. If any additional Material or Equipment is approved, the information will be published in an Addendum prior to the Bid Proposal submittal date. All Bid Proposals shall be based only on approved or specified Materials and Equipment. Thornton is not obligated to approve substitutions, either before Bid Proposal submission or after Notice of Award, regardless of whether Material, Equipment, or process is considered equivalent.

The successful Bidder, upon award of a Contract, shall commence Work on the date specified in the Notice to Proceed and shall diligently prosecute the Work and shall substantially complete all Work within the Contract Time. Should the Contractor fail to substantially complete all Work in the allotted time period, Liquidated Damages may be assessed.

At the Pre-Construction Meeting or within fourteen (14) Calendar Days after Notice of Award, whichever occurs sooner, the successful Bidder shall submit to Thornton a preliminary schedule showing the order in which the Bidder proposes to carry out the Work to successfully construct all of the Work within the Contract Time. This schedule shall be in addition to any other schedule requirements contained in the Contract Documents. Such preliminary schedule shall show the dates on which the Bidder will start and complete the parts of the Work and the order of construction and delivery dates of critical Materials and Equipment. The preliminary schedule shall be subject to acceptance by Thornton. The schedule shall be binding on the Bidder and shall be adhered to by the Bidder unless, for good cause shown, a modification of schedule shall be requested in writing to Thornton and approved by Thornton in accordance with the General Conditions of the Contract.

THE REMAINDER OF THIS PAGE INTENTIONALLY LEFT BLANK

PROCEDURE FOR CONTRACT SIGNING

- A. Signed Notice of Award - One (1) original of Notice of Award retained by Contract Administration One (1) copy of executed Notice of Award sent to Contractor.
- B. **The following electronic (digital) signing process will be used through a Thornton approved digital signature service:**
1. Signed Notice of Award - A digitally signed Notice of Award will be delivered to Contractor by e-mail or through an approved digital signature service.
 2. After Award, Contract Administrator will send a digital copy of the Contract documents to Contractor for the Bonding company for reference.
 3. Within ten (10) Calendar Days of Notice of Award, Contractor shall return executed bonds, insurance certificates, W-9, and applicable affidavits to Thornton. The following shall be submitted when returning the executed Bonds to Thornton:
 - i. A copy of the Certificate(s) of Insurance, the Additional Insured Endorsements, and ACORD Form 101 if required, showing all required insurance coverages and limits. Include the Project Number and Contractor's e-mail address on the face of the Certificate of Insurance for future updates and inquiries.

If the Acord Certificate is used, it must be a signed (not stamped) certificate.

Thornton, its officers, employees, and agents shall be named as Additional Insureds. This language is to appear on the face of the certificate. Additional Insured Endorsements, indicating completed operations coverage where applicable, must also be submitted.
 - ii. W-9 Taxpayer ID Form.
- C. Thornton will route the Contract documents to all signatories via an approved digital signature service.
1. Contractor signs and attests (if applicable) the Contract via the approved digital signature service. Note: The Contractor's representative signing the Contract must be authorized to bind the company in a contract with Thornton.
 2. If Contractor is a corporation, Contracts must be attested, and attestation witness must be an officer of the corporation of at least a Secretary rank (not a notary). If Contractor is not a corporation, attestation is not required.

3. Print title of the Contract signer, and the attestation witness if applicable, in the spaces provided.
 4. Note: The last City of Thornton signatory will date the Contract.
- D. Thornton's Contract Administrator will add the Certificate(s) of Insurance, Additional Insured Endorsements, ACORD Form 101 if applicable, executed Performance and Payment Bonds, and applicable Powers of Attorney, into the Project Manuals with the signed (and attested if applicable) Contracts prior to routing the document via approved digital signature service. **The last City of Thornton signatory will date the Contract on the first page.** One (1) fully executed electronic original will be sent to the Contractor via approved digital signature service for the Contractor's file. The Contractor is responsible for sending the Bonding Company one (1) fully executed copy.

Alternatively, if hard copies are preferred after Award, Contract Administrator sends four (4) copies of Contract (bound in Project Manual) to Contractor.

1. Contractor signs, and attests if applicable, all four (4) copies and returns all four (4) copies of Contract (bound in Project Manual) to Thornton's Contract Administrator.
 2. The Contractor's representative signing the Contract shall be authorized to bind the company in a contract with Thornton.
 3. If Contractor is a corporation, Contracts must be attested and attestation witness must be an officer of the corporation of at least a Secretary rank (not a notary). If Contractor is not a corporation, attestation is not required.
 4. Print title of the Contract signer, and the attestation witness if applicable, in the spaces provided.
 5. Do not date the Contract. The last City of Thornton signatory will date the Contract.
- E. Include the following when returning executed Contracts to Thornton. Note: All of the following materials must be returned within ten (10) Calendar Days of the Notice of Award, unless noted otherwise in the contract documents:
1. Four (4) copies of executed Performance Bond and Labor and Material Payment Bond, along with applicable Powers of Attorney, in one hundred percent (100%) of the Contract Price from a bonding company listed in the government approved list of bonding companies (Circular 570). Original signature, with witness signature or attestation if corporation, is required for all four (4) copies. Submit an executed Power of Attorney for each set of bonds.

2. Four (4) copies of the Certificate(s) of Insurance, the Additional Insured Endorsements, and ACORD Form 101 if required, showing all required insurance coverages and limits. Include the Project Number and Contractor's e-mail address on the face of the Certificate of Insurance for future updates and inquiries.

If the Acord Certificate is used, we must have a signed (not stamped) certificate.

Thornton, its officers, employees, and agents are to be named as Additional Insureds. This language is to appear on the face of the certificate. Additional Insured Endorsements, indicating completed operations coverage where applicable, must also be submitted.

3. W-9 Taxpayer ID Form.

- F. Thornton's Contract Administrator will bind the Certificate(s) of Insurance, Additional Insured Endorsements, ACORD Form 101 if applicable, executed Performance and Payment Bonds, and applicable Powers of Attorney, into the Project Manuals with the signed (and attested if applicable) Contracts and will route the Project Manuals for City of Thornton signatures. **The last City of Thornton signatory will date the Contract on the first page.** Two (2) fully executed originals will be returned to the Contractor, one (1) for the Contractor's file and one (1) for the Contractor's Surety.

THE REMAINDER OF THIS PAGE INTENTIONALLY LEFT BLANK

THIS PAGE INTENTIONALLY LEFT BLANK

BID PROPOSAL

To: City of Thornton
Attention: Contracts and Purchasing Director
9500 Civic Center Drive
Thornton, Colorado 80229

The undersigned Bidder, having examined the Specifications, Drawings, and all other documents contained in the Contract Documents, and having examined the Project site where the Work is to be performed, and having familiarized itself with all local conditions affecting the Work and having knowledge of the cost of Work, hereby proposes to execute and perform the Contract set forth in these Contract Documents, of which this Bid Proposal forms a part, and shall do the Work therein described in accordance with the terms and conditions therein set forth, and shall furnish all required labor, Materials, Equipment, tools, Construction Equipment, transportation and services for said Work, and shall pay all applicable fees, permits, taxes, and other incidental costs, all in strict conformity with the Contract Documents, for an amount computed upon the basis of the quantity of Work actually performed at the Bid Proposal prices provided below.

It is understood that any listed quantities of Work to be performed at Unit Prices, except those items specified to be paid at plan quantity, are approximate only and are intended principally to serve as a guide in evaluating Bid Proposals, and the Work will be paid by measuring actual quantities and multiplying the actual quantity by the agreed upon Unit Price. Listed quantities of Work specified to be paid at plan quantity are given as a convenience to assist the Bidder during the bid process and are approximate only, and both Bidder and Thornton agree that regardless of the actual final in place quantity the items of Work specified to be paid at plan quantities will not be measured for payment, and payment will be made based on the plan quantity specified multiplied by the agreed upon Unit Price.

It is further agreed that any quantities of Work to be performed and Material to be furnished at Unit Prices may be increased or decreased as may be considered necessary, in the opinion of Thornton, to complete the Work fully as planned and contemplated and that all quantities of Work or Materials, whether increased or decreased, are to be performed at the Unit Prices set forth in the Bid Proposal, except as provided for in the General Conditions.

It is further agreed that any Lump Sum Prices may be increased to cover Changed or Extra Work ordered by Thornton, but not shown on the Drawings or required by the Specifications, in accordance with the provisions of the General Conditions. Similarly, they may be decreased to cover deletion of Work so ordered.

It is further agreed that any combination of Unit Prices and Lump Sum Prices contained in the Bid Proposal, as applicable, may be used by Thornton to price Changed or Extra Work regardless of the scope or quantity of the change, except as may be otherwise provided for in the General Conditions.

By submitting this Bid Proposal, the Bidder acknowledges its understanding that the Bid process is solely intended to serve the public interest, in achieving the highest quality of services and goods at the lowest price and that no right, interest, or expectation shall vest or inure to the benefit of a Bidder as a result of any reliance or participation in the process. In submitting this Bid Proposal, it is understood that the right is reserved by Thornton to reject any or all Bid Proposals and waive informalities or irregularities in Bid Proposals.

The undersigned further agrees, if awarded the Contract for the Work included in this Bid Proposal, to begin and to complete the Work contemplated in accordance with all the conditions set forth in the Contract Documents.

The undersigned has carefully checked the Unit Prices, Lump Sum Prices, and Extended Prices inserted by it and understands that they are the Bidder's sole responsibility and that Thornton will not be responsible for any errors or omissions on the part of the undersigned Bidder in preparing this Bid Proposal.

The undersigned certifies that this Bid Proposal is genuine, not collusive, or made in the interest or behalf of any person not named as provided in the Instruction to Bidders and that the undersigned has not, directly or indirectly, induced or solicited any other Bidder, or induced any other person, firm or corporation to refrain from submitting a Bid Proposal, and the undersigned has not in any manner sought by collusion to secure for itself an advantage over any other Bidder.

The undersigned has attached a certified check without endorsement or conditions, payable to the City of Thornton, in the sum of five percent (5%) of the Bid Proposal, drawn on a bank which is a member of Federal Reserve System or which is a member of the Federal Deposit Insurance Corporation, or attach a cashier's check for five percent (5%) of the total Bid Proposal amount, or attach a Bid Bond written by a surety company approved by Thornton and listed in the most recent Federal Register Circular 570 or having a current Best's rating of A or better for five percent (5%) of the total Bid Proposal amount.

It is expressly understood that the check or bond is given as security and as a guarantee that the Bidder will, if awarded the Contract, timely execute the Contract, furnish an acceptable Performance Bond and Labor and Material Payment Bond on the forms included in the Contract Documents if required, furnish the required insurance, and furnish the other documents required by the Contract. The undersigned expressly acknowledges that the amount thereof represents the agreed damages that Thornton will sustain if the Bidder fails or refuses to execute and deliver within ten (10) Calendar Days from and including the date of the Notice of Award, the Contract, the required Performance Bond and Labor and Material Payment Bond, the required insurance, and the other documents required by the Contract, in which event said check or bond shall be immediately payable to and retained by Thornton.

The Bidder grants Thornton the right to hold the lowest three (3) Bid Proposals received, together with the accompanying Bid Proposal securities, for a period of sixty (60) Calendar Days after the date of submission of the Bid Proposals and to delay Notice of Award until the end of such time period.

The undersigned Bidder further grants Thornton the right to award this Contract on the basis of any possible combinations of base Bid Proposal and add or deduct alternate(s), if any, that best suits Thornton's needs.

The undersigned Bidder further agrees to furnish to Thornton all such information and data deemed by Thornton to be necessary to determine the ability of Bidder to perform the Work, and within two (2) Business Days of Bid Proposal submission, shall provide Thornton a completed Reference Authorization and Release Form, a copy of which is included herein.

The Bidder's attention is directed to the fact that all applicable state and federal laws, county and city ordinances, licenses and regulations of all authorities having jurisdiction over the Project shall apply to the Contract throughout, and they will be deemed to be included in the Contract the same as though herein written out in full.

The undersigned Bidder acknowledges that the City of Thornton Charter Section 7.4 prohibits Thornton from making Contracts with firms which employ certain relatives of Thornton employees unless the City Council determines that the making of such a Contract is in Thornton's best interest. For the purposes of this Charter Section, relative shall include domestic partners. The undersigned Bidder attests to the following:

No City Council Member, member of a board or commission, Municipal Judge, City Manager, City Attorney, or employee of the City of Thornton or any such person's family member, domestic partner, or person assuming a relationship being the substantial equivalent of the above, has an existing or pending, direct or indirect, financial, pecuniary or personal interest in the Bidder or with this Invitation for Bid Proposals, except as follows (list, if none state "None"): _____

The undersigned Bidder acknowledges the following Addenda (if none, so state):

Addendum #	Dated	Initial
_____	_____	_____
_____	_____	_____
_____	_____	_____
_____	_____	_____
_____	_____	_____
_____	_____	_____

The undersigned Bidder expressly agrees to the following provisions:

- A. That the Bid Proposal stated shall include the utilization of the Subcontractor(s) and Supplier(s) listed in the List of Subcontractors/Suppliers below.
- B. That the Subcontractor(s) and Supplier(s) listed below shall not be changed by the Bidder unless the Subcontractor(s) or Supplier(s) are unable to perform due to bankruptcy, labor strikes, or termination of business by the Subcontractor(s) or Supplier(s).
- C. That any Subcontractor(s) and Supplier(s) shall be subject to Thornton's approval.

List below any Subcontractor(s) and Supplier(s) whose contract(s) exceeds ten thousand dollars (\$10,000).

	SUBCONTRACTOR/SUPPLIER	TYPE OF WORK
1.	_____	_____
2.	_____	_____
3.	_____	_____
4.	_____	_____
5.	_____	_____
6.	_____	_____
7.	_____	_____
8.	_____	_____
9.	_____	_____
10.	_____	_____
11.	_____	_____
12.	_____	_____
13.	_____	_____
14.	_____	_____
15.	_____	_____

Attach additional sheet if more space is needed.

SCHEDULE OF CONTRACT PAY ITEMS AND PRICES
Zadel Reservoir Fencing
Project No. 18-554

Item No.	Description	Unit	Quantity	Price	Total Price
1	Mobilization	LS	1		
2	7-foot Chain Link Fence	LF	9,635		
3	24-foot Double Gate	EA	1		
				GRAND TOTAL	

Indicate if you are claiming eligibility for Local Vendor Consideration by checking below, and if so, supply the required documentation.

Yes, Bidder claims eligibility for Local Vendor Consideration.

No, Bidder does not claim eligibility for Local Vendor Consideration.

SCHEDULE OF CONTRACT ITEMS AND PRICES

Total Bid Proposal _____ Dollars

(Words)

_____ Cents

(Words)

\$ _____

(Numerals)

Dated this _____ day of _____, 20__.

Firm Name: _____

Authorized Signer (Print Name): _____

Signature: _____

Title: _____

Bidder's Legal Status: _____

State of Organization: _____

Firm's Address: _____

Telephone: _____

E-mail: _____

Witness: (Attest and Seal if Bid Proposal is by Corporation)

CONTRACTOR'S POST QUALIFICATIONS

Must be submitted by the apparent successful Bidder within two (2) Business Days of notification by Thornton. Failure to do so may be cause for Thornton to determine that the apparent successful Bidder is non-responsive and may subject the apparent successful Bidder to forfeiture of its Bid Bond.

Submit to: City of Thornton, Contract Administration
Address: 9500 Civic Center Drive, Thornton, CO 80229
Attention: Patrick Hinterberger, Contracts Supervisor
Email: patrick.hinterberger@thorntonCO.gov
Fax: 303-538-7556

THIS PAGE INTENTIONALLY LEFT BLANK

REFERENCE AUTHORIZATION AND RELEASE FORM

By: _____, A Corporation
(Proposing firm) , A Partnership whose address is:
An Individual

Proposing Firm has submitted a sealed proposal to the City of Thornton (Thornton) for engineering services for the Zadel Reservoir Fencing, Project No. 18-554 (Project).

Proposing Firm hereby authorizes Thornton to perform such investigation of proposing firm as it deems necessary to verify the qualifications, responsibility, trustworthiness and financial ability of Proposing Firm. By its signature hereon, the proposing firm authorizes Thornton to obtain reference information concerning the proposing firm. Proposing Firm further agrees to release and hold Thornton and the firm or agency providing reference information harmless from all liability resulting from providing the requested reference information to Thornton about the Proposing Firm.

Proposing Firm further authorizes Thornton to discuss and release reference information regarding Proposing Firm's performance as it will relate to this upcoming Project upon receiving a request for such information. Proposing Firm agrees to release and hold Thornton harmless from all liability associated with releasing such information about Proposing Firm.

Proposing Firm further waives its right to receive copies of reference information provided to Thornton. By signing below, Proposing Firm agrees with the terms of this Reference Authorization and Release and authorizes Thornton to obtain reference information concerning Proposing Firm.

A copy or facsimile of this executed Reference Authorization and Release Form may be used with the same effectiveness as an original.

Signature Date

Print Name

Title

THIS PAGE INTENTIONALLY LEFT BLANK

POST-QUALIFICATION QUESTIONNAIRE

1. How many years has your organization been in business as a General Contractor under the present firm's name? _____

2. How many years has your organization been in business under other business name(s)? _____ List other names: _____

3. If a corporation, answer the following:

Date of incorporation: _____

State of incorporation: _____

President: _____

Vice-President(s): _____

Secretary: _____

Treasurer: _____

4. If a partnership, answer the following:

Date of organization: _____

Type of partnership: _____

(General/Limited/Assoc)

Name and address _____
of all partners: _____

5. If other than a corporation or partnership, describe the organization form and provide the name and address of all principals:

6. List the trades and percent of the total contract you normally perform with your own forces:

_____ %
_____ %
_____ %
_____ %
_____ %

Percent of total contract by dollar amount typically self-performed: _____ %

7. Have you ever failed to complete any work awarded to you? _____ If so, indicate when, where, and why below. Have you ever been declared in default on a contract? _____ If "yes", indicate when, where, and why below.

8. Has any director, officer, or partner of your firm ever been a director, officer, or partner of another organization that failed to complete a construction contract? _____ If "yes", state circumstances below.

9. Has your firm ever failed to be awarded a contract on which your firm was low bidder? _____ If "yes", state when, where, and why below.

10. Has your firm in the past two (2) years, or is your firm at the present time, late in the completion of any projects for a government agency? _____ If "yes", list all applicable projects and state when, where, and why below.

11. Liquidated damages and/or disputes: List all government or agency projects in the last two (2) years where Liquidated Damages were or may be assessed, and where substantial disputes on projects occurred or are currently occurring. Attach a detailed explanation, using an additional sheet if necessary.

12. Has your firm's bonding company been contacted in the past two (2) years concerning either the late completion of a project or the non-payment of subcontractors or suppliers? _____ If "yes", explain the circumstances in detail.

13. List all major construction projects your firm currently has under contract in Colorado on this date:

Project Name _____
Owner _____ Phone Number _____
Architect/Engineer _____ Phone Number _____
Contract Amount _____ Contract Date _____
Percent Complete _____ Original Scheduled Completion Date _____
Change Order Amount to Date _____ Current Scheduled Completion Date _____

Project Name _____
Owner _____ Phone Number _____
Architect/Engineer _____ Phone Number _____
Contract Amount _____ Contract Date _____
Percent Complete _____ Original Scheduled Completion Date _____
Change Order Amount to Date _____ Current Scheduled Completion Date _____

Project Name _____
Owner _____ Phone Number _____
Architect/Engineer _____ Phone Number _____
Contract Amount _____ Contract Date _____
Percent Complete _____ Original Scheduled Completion Date _____
Change Order Amount to Date _____ Current Scheduled Completion Date _____

Project Name _____
Owner _____ Phone Number _____
Architect/Engineer _____ Phone Number _____
Contract Amount _____ Contract Date _____
Percent Complete _____ Original Scheduled Completion Date _____
Change Order Amount to Date _____ Current Scheduled Completion Date _____

Project Name _____
Owner _____ Phone Number _____
Architect/Engineer _____ Phone Number _____
Contract Amount _____ Contract Date _____
Percent Complete _____ Original Scheduled Completion Date _____
Change Order Amount to Date _____ Current Scheduled Completion Date _____

(Attach additional sheet if necessary.)

14. List major construction projects similar to this Project that your firm has completed in Colorado in the past three (3) years. Bidder must have significant, recent, similar, experience to be considered qualified.

Project Name _____
Owner _____ Phone Number _____
Architect/Engineer _____ Phone Number _____
Original Contract Amount _____ Final Contract Amount _____
No. of Change Orders _____ Contract Date _____
Original Completion Date _____ Actual Completion Date _____

Project Name _____
Owner _____ Phone Number _____
Architect/Engineer _____ Phone Number _____
Original Contract Amount _____ Final Contract Amount _____
No. of Change Orders _____ Contract Date _____
Original Completion Date _____ Actual Completion Date _____

Project Name _____
Owner _____ Phone Number _____
Architect/Engineer _____ Phone Number _____
Original Contract Amount _____ Final Contract Amount _____
No. of Change Orders _____ Contract Date _____
Original Completion Date _____ Actual Completion Date _____

Project Name _____
Owner _____ Phone Number _____
Architect/Engineer _____ Phone Number _____
Original Contract Amount _____ Final Contract Amount _____
No. of Change Orders _____ Contract Date _____
Original Completion Date _____ Actual Completion Date _____

Project Name _____
Owner _____ Phone Number _____
Architect/Engineer _____ Phone Number _____
Original Contract Amount _____ Final Contract Amount _____
No. of Change Orders _____ Contract Date _____
Original Completion Date _____ Actual Completion Date _____

Project Name _____
Owner _____ Phone Number _____
Architect/Engineer _____ Phone Number _____
Original Contract Amount _____ Final Contract Amount _____
No. of Change Orders _____ Contract Date _____
Original Completion Date _____ Actual Completion Date _____

Project Name _____
Owner _____ Phone Number _____
Architect/Engineer _____ Phone Number _____
Original Contract Amount _____ Final Contract Amount _____
No. of Change Orders _____ Contract Date _____
Original Completion Date _____ Actual Completion Date _____

15. List the years of construction experience of all the principal individuals in your organization located in Colorado. Identify those individuals that will be assigned to this Project by indicating the percent of their time to be dedicated to this Project.

<u>Name</u>	<u>Position</u>	<u>Yrs. Experience</u>	<u>% Time</u>
_____	_____	_____	_____
_____	_____	_____	_____
_____	_____	_____	_____
_____	_____	_____	_____
_____	_____	_____	_____

16. Provide resumes of your proposed Project Manager and Superintendent and include references for each from owners and consulting engineers or architects for their last three (3) projects. Of the similar completed projects listed previously, indicate which were worked on by your proposed Project Manager and Superintendent.

17. Include a proposed project organization chart showing key staff, their area of responsibility, and the date they will be available to begin Work on the Project.

18. List major equipment available for this Project:

_____	_____	_____
_____	_____	_____
_____	_____	_____
_____	_____	_____
_____	_____	_____
_____	_____	_____

19. Indicate the firm's resources available for cost estimating, scheduling, project management (document and issue tracking), procurement, and cost tracking, including software utilized and the staff member(s) assigned to this Project that have expertise in its use.

22. Safety Record:

- a. Provide the firm's Incidence rate of non-fatal occupational injuries and illnesses per one hundred (100) full time workers (Total Recordable Cases or TRC rate) as defined by the Bureau of Labor Statistics, Table 1 over the prior three (3) year period. Refer to <http://www.bls.gov/iif/oshsum.htm>, Yr. 1_____, Yr. 2_____, Yr. 3_____.
- b. Provide the Incidence rate of non-fatal occupational injuries and illnesses per one hundred (100) full-time workers (Total Recordable Cases or TRC rate) as defined by the Bureau of Labor Statistics, Table 1 over the prior three (3) year period for the projects on which the proposed Superintendent or Project Manager worked (depending on who is assigned site safety responsibility in the Contractor's organization). Yr. 1_____, Yr. 2_____, Yr. 3_____.
- c. Provide the firm's Workers' Compensation Experience Modification Rate Factor (EMRF) for the prior three (3) years from the National Council on Compensation Insurance, Inc. (NCCI, www.ncci.com). _____

- d. Indicate the number of fatal accidents that occurred on any of your firm's projects in the last three (3) year period. _____. Describe circumstances and whether any corrective action was required or if any fines were levied by OSHA or other governmental agency.

A TRC rate in excess of the national average in any given year for the applicable industry or an EMRF in excess of 1.2 in any given year may be cause for disqualification.

23. Describe any experience by the firm or key staff with partnering, both formal and informal. Highlight the partnering experience by key staff proposed for this Project. Indicate if the firm plans to conduct any partnering sessions on this Project.

(Use additional sheet if necessary.)

24. List states and categories in which the firm is legally qualified or licensed to do business.

25. Bank References:

- a. Provide the contact name, bank name and address, and telephone number of the firm's banking references.

_____	_____	_____
_____	_____	_____
_____	_____	_____

- b. Provide a letter of reference from the firm's primary operating bank.

26. Trade References - Provide the contact name, company name and address, and telephone number of subcontractors and suppliers frequently used by your firm:

_____	_____	_____
_____	_____	_____
_____	_____	_____

27. Bonding Company:

- a. Provide the name, address, and telephone number of the firm's bonding agent.

- b. Provide a letter from the bonding agent indicating the firm's bonding capacity and that it is adequate to undertake this Work. Indicate what portion remains of this bonding capacity at the time of Post-qualification submittal.

28. Insurance Company:

- a. Provide the name, address, e-mail addresses, and telephone number of the firm's insurance agent(s) and the names and ratings of the insurance companies.

Worker's Comp: _____

General Liability: _____

Builder's Risk and/or Installation Floater: _____

Auto Liability: _____

Other: _____

- b. Provide certificate(s) of insurance outlining coverage and policy limits.
- c. Indicate if any of the coverages can be increased, and whether there are any current claims that will affect coverage limits available to Thornton for this Project.

29. In a separate sealed envelope labeled with the Project Name and Project Number, the firm's name, the date submitted, and marked "CONFIDENTIAL – CLAIM AND LITIGATION RECORD", provide the following:

- a. A list of the construction projects, along with address and telephone number of the owner, to which the firm or any of the firm's directors, partners, or officers were party in their role as director, partner, or officer of the firm, during the previous ten (10) years if such projects were the subject of formal arbitration or litigation of any type. If the dispute resulted in a confidential settlement agreement, the names of the parties involved may be redacted, but the project must be listed.
- b. Indicate if any judgments have been entered within the last five (5) years against your firm or against any of the firm's directors, partners, or officers related to their role in the performance of construction projects with the firm or with prior construction firms. If so, provide a list of Judgment Creditors, where docketed and date, and amount for each. Indicate if any of the judgments included an award of attorneys' fees as a sanction. If yes, explain why.
- c. A list of current lawsuits that are pending at this time against the firm, or against any of the directors, partners, or officers of the firm related to their role in the performance of construction projects with the firm. Indicate the parties and summarize the nature of the dispute.

30. Was the firm or any of its directors, partners, or officers ever suspended, debarred, or determined to be ineligible from entering into contracts with any federal, state, or local governmental entity? _____ If "yes", give details:

31. Criminal Convictions: Indicate if the firm, or any of its officers, employees, subsidiary companies, or affiliates has pled guilty, nolo contendere, or been convicted of any crimes, including petty offenses, misdemeanors, or felonies, in any jurisdiction in the United States, related to perjury, bidding, labor, taxes, wages, safety, environmental, or performance of construction contracts within the past five (5) year period.

32. Financial Capacity:

By submission of the Post-Qualification Affidavit, the bank letter of reference, and the bonding company letter required herein, the Bidder certifies that it has adequate financial capacity to perform the Work in accordance with the Contract Documents.

BIDDER'S POST-QUALIFICATION AFFIDAVIT

The undersigned, as _____
(Owner, Officer or Director of Corporation, Partner, or Member of Firm)
of the Bidder, hereby certifies that the foregoing information is, to the best of his/her
knowledge and belief, true and accurate as of the _____ day of _____,
20____. Bidder, by its signature hereon, authorizes the obtaining of reference information
and hereby releases the party providing such information and the City of Thornton from any
and all liability to Bidder as a result of such reference information being provided. Bidder
further waives any right to receive copies of information so provided.

Corporate Seal
(If Corporation)

Signature

Print Name

Title (must be Owner, Officer of
Corporation or member of Partnership as
applicable)

NOTARY

STATE OF COLORADO)
) ss
COUNTY OF _____)

The foregoing instrument was acknowledged before me this _____ day of
_____, 20__, by _____ as _____ for
the _____.

WITNESS my hand and official seal.

My commission expires: _____

Notary Public

THIS PAGE INTENTIONALLY LEFT BLANK

EXHIBIT A

SPECIAL CONDITIONS

Table of Contents

- I. DEFINITIONS - INTENTIONALLY OMITTED**
- II. SUBMITTALS, SHOP DRAWINGS, AND SAMPLES**
- III. WARRANTY PERIOD (ARTICLE VIII OF GENERAL CONDITIONS)**
- IV. COORDINATION WITH OTHER ENTITIES - INTENTIONALLY OMITTED**
- V. APPROVED CERTIFIED INSTALLATION CONTRACTORS - INTENTIONALLY OMITTED**
- VI. ESCROW OF PROPOSAL DOCUMENTATION - INTENTIONALLY OMITTED**
- VII. MEASUREMENT FOR PAYMENT**
- VIII. MOBILIZATION**
- IX. PROJECT MEETINGS**
- X. QUALITY ASSURANCE INSPECTION AND TESTING**
- XI. RECORDKEEPING AND AUDITS**
- XII. SOILS TESTS - INTENTIONALLY OMITTED**

THIS PAGE INTENTIONALLY LEFT BLANK

I. DEFINITIONS – INTENTIONALLY OMITTED

II. SUBMITTALS, SHOP DRAWINGS, AND SAMPLES

- A. Thornton’s designated representative(s) shall have **FOURTEEN (14)** Calendar Days to review and approve or reject Shop Drawings and Samples, unless otherwise stated in the Specifications. Rejected items shall be resubmitted to Thornton and subsequent review by Thornton will be within **FOURTEEN (14)** Calendar Days. See also General Conditions - Submittals, Shop Drawings, Samples, Service Parts Manuals, and Operator’s Instructions.
- B. Contractor’s submittal and Thornton’s review and/or acceptance of Shop Drawings, Product Data or Samples that relate to construction activities not complying with the Construction Documents, does not constitute an acceptable or valid request for substitution, nor does it constitute approval. Any deviations from the Drawings and Specifications shall clearly reference the approved substitution request and shall comply with all submittal requirements in the Construction Documents.

III. WARRANTY PERIOD (ARTICLE VIII OF GENERAL CONDITIONS)

- A. Notwithstanding Article VIII. – Warranty Period, as it pertains to erosion control management and maintenance, the Warranty Period pertaining to erosion control will extend to such date until the site has achieved stabilization in accordance with the Stormwater Management Permit for the Project such that the permit is closed.

IV. COORDINATION WITH OTHER ENTITIES – INTENTIONALLY OMITTED

V. APPROVED CERTIFIED INSTALLATION CONTRACTORS – INTENTIONALLY OMITTED

VI. ESCROW OF PROPOSAL DOCUMENTATION – INTENTIONALLY OMITTED

VII. MEASUREMENT FOR PAYMENT

- A. Thornton shall determine all quantities, amounts of Work done, and percentages complete under the Contract. To assist Thornton in determining quantities, the Contractor shall first measure and quantify all Work. At the time quantity measurements are made by the Contractor, Thornton’s Representative may be present to verify and agree to such measurements. If Thornton or Thornton’s Representative disagrees with Contractor’s measurements, Thornton may, at its option, independently measure quantities and adjust payments in accordance with its measurements. The Contractor shall fully cooperate with Thornton in any such endeavor at no additional cost to Thornton.

- B. Using quantity figures agreed to by the Parties, it will be the Contractor's responsibility to prepare a monthly Application for Payment for the Work accomplished to date. Thornton at its sole option may prepare and provide a pay application to the Contractor. The Application for Payment shall not include charges relating to rejected Change Order Requests nor Re-work. If the Parties cannot agree on the quantities and the resulting amount of payment, Thornton may, but shall not be obligated to, prepare an Application for Payment on the Contractor's behalf.
- C. Applications for Payment shall be submitted each month, or on another schedule as the Parties may agree upon, on the date designated by Thornton. Failure of the Contractor to timely submit a complete, correct, and certified Application for Payment (accompanied by an updated Schedule of Work) may cause a delay in payment.
- D. By submitting the signed Application for Payment, the Contractor certifies that to the best of the Contractor's knowledge, information, and belief the Work covered by the Application for Payment has been completed in accordance with the Contract Documents, that all amounts have been paid by the Contractor to its Subcontractors and suppliers for Work for which previous Certificates for Payment were issued and for which payments were received from Thornton, and that the current payment shown in the Application for Payment is now due.
- E. Upon Thornton's request, the Contractor shall submit, along with its monthly Application for Payment for Work completed, an estimate of the Work that will be completed during the following month.
- F. If not otherwise specified in a Measurement and Payment section, when items are specified to be paid for by the ton, the following system will be used.

VIII. MOBILIZATION

- A. The Special Conditions Mobilization requirements indicated below take precedent over the General Conditions.
- B. The Pay Item price for mobilization shall also include any "start-up" or incidental costs necessary to begin the Work, including any necessary Construction Equipment, offices, buildings, Materials or Equipment, personnel that are to be located at the Project site in preparation for the Work, Bonds, Insurance, permits, and any other incidental expenses that cannot otherwise be attributed directly to the other Bid Proposal Pay Items. Mobilization also includes any demobilization costs to remove or decommission the materials, equipment and personnel identified in mobilization costs.

C. Payments for mobilization shall be made on a monthly basis in accordance with the following formula:

Contract Amount Completed		Mobilization Paid
5%	=	25%
10%	=	50%
25%	=	60%
50%	=	100%

D. The overall Pay Item price for mobilization should not exceed ten percent (10%) of the original Contract Price. If the overall Pay Item price for mobilization exceeds ten percent (10%), and if Thornton does not reject the Bid, Thornton shall have the option of withholding payment of the amount exceeding ten percent (10%) of the Contract Price until the date of Final Payment.

E. Demobilization costs are considered incidental to the Mobilization.

IX. PROJECT MEETINGS

A. Meetings shall be held between Thornton, Contractor, and other applicable entities at a standard time and place as determined at Thornton's sole discretion, established during the Preconstruction Meeting. Meetings are to be typically held on at least a weekly basis unless otherwise mutually agreed to by the Parties. Thornton shall require the attendance of Contractor's Superintendent and any other person(s) deemed necessary, including Subcontractors and or suppliers, at these meetings. The meetings shall be conducted by the Contractor for the following purposes:

1. Review the overall progress of the Work and the current status of the Schedule of Work;
2. Review Contractor provided two week look ahead Schedule;
3. Identification and resolution of problems which are or may be impeding the planned progress of the Work;
4. Coordination of the efforts of concerned Parties so that the Work progresses per the Schedule of Work;
5. Maintenance of lines of communication, including sound working relationships between Thornton and Contractor, and a mutual understanding of requirements of the Contract Documents;
6. Review and discuss any safety concerns and or accidents;
7. Review and discuss any pending change order request;

8. Review and discuss current Requests for Information (RFI's);
 9. Review and discuss open submittals;
 10. Review and discuss current application for payment; and
 11. Review other business as required.
- B. Contractor shall be responsible for the preparation and distribution of written minutes of these meetings to all attendees and other concerned or impacted parties, as designated by Thornton. Contractor shall distribute meeting minutes within three (3) Calendar Days of the meeting. Within seven (7) Calendar Days of receipt of the meeting minutes, Thornton shall review the content for completeness and accuracy, and note modifications and/or corrections. Contractor shall incorporate modifications and/or corrections into the meeting minutes as deemed appropriate by Thornton, and the revised meeting minutes will be re-distributed to all attendees by Contractor within three (3) Calendar Days or prior to next meeting.

X. QUALITY ASSURANCE INSPECTION AND TESTING

- A. Quality Assurance (QA) inspections and tests such as, but not limited to, fill control (compaction), asphalt density, rebar inspection, and concrete testing, shall be performed by a commercial testing laboratory of Thornton's choosing and at Thornton's expense. The Contractor may observe all such Quality Assurance inspections and tests.
- B. Thornton's Quality Assurance inspections and tests are for Thornton's benefit. Thornton's Quality Assurance inspections and tests are not a substitute for the Contractor's Quality Control (QC) responsibilities or its testing and inspection program. The Contractor is solely responsible for performing and paying for all necessary Quality Control Tests.
- C. Contractor is responsible for coordinating initial material samples (i.e., soil for proctor establishment) on the job site so that QA and QC testing criteria are established and agreed to prior to actual material testing. Furthermore, Contractor is required to coordinate and schedule all subsequent QA (at the Thornton approved frequencies) and QC testing throughout the entirety of the Project. Note that Contractor shall assume costs related to unnecessary site visits by QA agency due to canceled or erroneously scheduled testing and Thornton shall have the right to back charge the Contractor for the related costs and to deduct those costs from payments due or that become due to the Contractor.
- D. In the event a Quality Assurance and/or a Quality Control inspection or test fails to meet the criteria established by the Specifications, Contractor shall notify Thornton and Consultant(s) in writing of the deviation from specification. If the failing test cannot be rectified and retested to meet the required specification, an RFI shall be issued by Contractor to determine the required course of action. If additional

inspections or tests must be performed after the necessary corrective Work is complete, the Contractor shall bear the expense of all the re-inspections and/or re-tests required. Thornton shall have the right to back charge the Contractor for re-inspections and re-tests and to deduct the cost of re-inspections and re-tests from payments due or that become due to the Contractor.

- E. Notwithstanding the above, at its sole option, Thornton may seek alternate means of resolution for work not in compliance with Contract Documents. This may include compensation, extended warranty, or other terms acceptable to Thornton. Acceptance of alternate means of resolution shall be documented in a written change order.
- F. Contractor shall perform excavation Work necessary for compaction testing, as requested by Thornton, at no additional cost to Thornton.

XI. RECORDKEEPING AND AUDITS

- A. Contractor shall keep full and detailed records and accounts relating to its performance of the Contract as may be necessary for proper management of the Work. All financial information shall be maintained in accordance with generally accepted accounting principles. Contractor's records and accounts shall include, but not be limited to, all estimating and bid preparation documents (EPD); correspondence; internal office correspondence; internal memos; conversation memorandums; policies and procedures; subcontract files; Change Order files; back charge logs and supporting documentation; RFI files, Submittal Files, daily reports, plan and specification modifications, and scheduling files; job cost and man-hour records; invoices; delivery tickets; bills of sale; all documentation relating to disputes or claims; safety reports; accident reports; photographs organized by room or elevation (if applicable); videos; accounting records; daily reports; and any other supporting evidence deemed necessary by Thornton to substantiate charges, expenses, or costs related to the Contract.
- B. Contractor's records and accounts shall be open to inspection and subject to audit and/or reproduction in any tangible form, including computer readable data by Thornton, to permit full and complete evaluation and verification of any:
 - 1. Requests or claims by Contractor, its Subcontractors, or its suppliers for any additional compensation related to the Contract;
 - 2. Contractor representations, warranties and/or guarantees under the Contract; or
 - 3. Legal action by Contractor, its Subcontractors, or its suppliers involving Thornton and related to the Contract.

- C. Such inspections and audits may require copying from time to time at reasonable times and places of any and all information, materials and data of every kind and character, including without limitation: records; books; papers; documents; subscriptions; recordings; agreements; Purchase Orders; leases; contracts; subcontracts; commitments; arrangements; notes; daily diaries; supervisory reports; drawings; sketches; receipts, vouchers; memoranda; and any and all other agreements, sources of information and matters that may in Thornton's judgment have any bearing on or pertain to any matters, rights, duties, or obligations under or covered by the Contract Documents. Such records subject to inspection and audit shall also include, but not be limited to, those records necessary to evaluate and verify direct and indirect costs (including overhead allocations) as they may apply to costs associated with the Contract or to a Claim for additional compensation and/or time.
- D. Thornton shall be afforded access to all of the Contractor's records and shall be allowed to interview any of the Contractor's employees (including contract labor), pursuant to the provisions of this section throughout the term of the Contract and for a period of three (3) years after Initial Acceptance of the Work, or longer if required by law.
- E. Contractor shall require all Subcontractors, sub-subcontractors and suppliers to comply with the provisions of this section by insertion of the requirements in its written agreements with those parties. Contractor shall cooperate fully and shall cause all related parties, including Contractor's Subcontractors entering into subcontracts, to cooperate fully in furnishing or in making available to Thornton from time to time whenever requested in an expeditious manner any and all such information, materials and data.
- F. Thornton shall have access to the Contractor's facilities, shall have access to all necessary records, and shall be provided adequate and appropriate workspace in order to conduct inspections and audits in compliance with this section.

XII. SOILS TESTS – INTENTIONALLY OMITTED

EXHIBIT B
City of Thornton
GENERAL CONDITIONS

Table of Contents

- I. DEFINITIONS
- II. THORNTON'S ROLE, RESPONSIBILITIES
- III. CONTRACTOR'S ROLE, RESPONSIBILITIES
- IV. PROJECT INFORMATION, SUBMITTALS, RECORD DOCUMENTS
- V. PROJECT AND CONSTRUCTION MANAGEMENT
- VI. QUALITY ASSURANCE AND QUALITY CONTROL, THORNTON INSPECTION OF WORK
- VII. PRODUCT SUBSTITUTIONS AND "OR EQUAL" CLAUSE
- VIII. WARRANTY PERIOD
- IX. MINOR CHANGES, CLAIMS FOR CHANGES IN THE WORK & CONTRACT PRICE
- X. CONTRACT TIME
- XI. DIFFERING SITE CONDITIONS
- XII. PARTIAL USE; RIGHT OF OCCUPANCY
- XIII. SUBSTANTIAL COMPLETION
- XIV. PAYMENTS
- XV. INITIAL ACCEPTANCE
- XVI. UTILITY LOCATIONS, RIGHT OF WAYS (ROW) & SERVICE
- XVII. ROADS, TRAFFIC, TRAVEL CONTROL & MAINTENANCE
- XVIII. EMERGENCY PROTECTION
- XIX. PROTECTION OF PUBLIC AND PRIVATE PROPERTY
- XX. COMPLIANCE WITH CURRENT LAWS
- XXI. STOP WORK, SUSPENSION AND TERMINATION

XXII. TAXES

XXIII. CONFIDENTIALITY

XXIV. WATER

XXV. ETHICS, NO FINANCIAL INTEREST, CONFLICTS AND RELATIONSHIPS

XXVI. DISPUTE RESOLUTION

XXVII. MISCELLANEOUS

I. DEFINITIONS

- A. "Additional Work" means services outside the Agreement's initial scope of Work, which may be added by Thornton. Additional Work may be negotiated separately and must be approved in writing by Thornton in an executed Change Order prior to performance.
- B. "Agreement" means the Construction Agreement between Thornton and Contractor, including Amendments, Change Orders, exhibits, and any other documents made part of the Agreement upon or after its execution.
- C. "Amendment" is a written document signed by Thornton and Contractor after execution of the Agreement, indicating changes in the terms and conditions of the Agreement.
- D. "Application for Payment" is the application submitted by Contractor for payment for Work performed during a pay period.
- E. "Change Order" is a written order signed by Thornton and Contractor after execution of the Agreement, indicating changes in the scope of the Work, Contract Price, or the Contract Time.
- F. "Change Order Request" (COR) - is a Contractor generated document that describes a change in the scope of Work, including a detailed description, Drawings and Specifications, and a request for changes to costs or time, as necessary, to inform Thornton of the nature of the requested change to the Contract.
- G. "Construction Equipment" means all plant, machinery, tools and apparatus, including parts and supplies for operation and maintenance, which are necessary for the proper construction and acceptable completion of the Work.
- H. "Contract Documents" consist of those documents identified in the Agreement and Change Orders and Amendments issued after execution of the Agreement.
- I. "Contract Price" defined in the Agreement as the amount Thornton agrees to pay the Contractor for the Work, which may be revised by a Change Order.
- J. "Contract Time" is the number of Days commencing on the Date of Commencement given in the Notice to Proceed for Construction, including time extensions authorized by Change Order, needed to achieve Substantial Completion of the Work. Where a calendar date for Substantial Completion is specified, the Work shall be substantially completed on or before that date, as may be revised by Change Order.
- K. "Contractor" is the person or entity identified as such by the Agreement and is referred to throughout the Contract Documents and if required, will be lawfully licensed to work in Thornton. The term Contractor includes Contractor's authorized representative.

- L. “Critical Path Method (CPM) Schedule” means Contractor’s schedule for the construction of the Work and is one of several related techniques for doing project scheduling. CPM is comprised of a number of individual tasks or activities where some of the activities start or finish dates are dependent on the progress of one or more other activities, and the schedule shows the nature of the interdependencies and the critical path through the schedule. The CPM Schedule may also show the resources needed for each task or activity.
- M. “Date of Commencement” shall be set forth in a Notice to Proceed for Construction to be issued to Contractor by Thornton.
- N. “Date of Final Settlement” is the date designated by Thornton in accordance with C.R.S. § 38-26-107, as may be amended, for making Final Payment to Contractor.
- O. “Date of Substantial Completion” is the date on which all the Work is required to be substantially completed; may also be called “Substantial Completion Date”.
- P. “Day” in any Contract Document refers to a Calendar Day of twenty-four (24) hours measured from midnight to the next midnight.
- Q. “Defective Work” is any Work not in conformance with the requirements of the Contract Documents.
- R. “Drawings” are the graphic and pictorial portions of the Contract Documents, wherever located and whenever issued, showing the design, location and dimensions of the Work, generally including plans, elevations, sections, details, schedules, diagrams, and notes, also sometimes referred to as plans. The Drawings may contain Specifications, and the Specifications may contain Drawings.
- S. “Engineer” means licensed architect or engineer (or its consultant) assigned by Thornton to perform design and engineering services for the project.
- T. “Final Acceptance” of the Work occurs on the date when Contractor’s obligations under the Agreement are complete, Thornton has acknowledged that the Warranty Correction Period has expired and all outstanding items requiring correction have been repaired to the satisfaction of Thornton, and there are no other outstanding warranty items to be corrected.
- U. “Final Payment” is the payment of all outstanding balances due, including retainage, following completion of the Work and issuance of Initial Acceptance by Thornton. Final Payment is payable on the Date of Final Settlement following advertisement of the Notice of Final Settlement and completion of the waiting period for submission of Verified Claims, provided there are no pending claims.
- V. “General Conditions Fee” if applicable and defined in the Contract Documents, are costs that are required to be incurred for successful completion of the Project but are not for items incorporated into the Work.

- W. “Hazardous Material” is any substance or material identified now or during the term of the Agreement as hazardous under any Laws or any other substance or material which may be considered hazardous or otherwise subject to statutory or regulatory requirements governing handling, disposal or clean-up.
- X. “Initial Acceptance” of the Work, or of a designated portion when allowed by the agreement, occurs when Thornton acknowledges that, to the best of its knowledge, all Work, including Punch List items, have been completed in accordance with the Contract Documents. Initial Acceptance shall not release the Contractor of any Warranty obligations.
- Y. “Laws” mean federal, state and local Laws, ordinances, codes, rules, and regulations applicable to the Work with which Contractor must comply that are enacted as of the date of the Agreement.
- Z. “Materials” and/or “Equipment” are all components, articles, appliances, devices, substances, supplies, and miscellaneous items specified or required for incorporation into the construction of the Work. Other materials and equipment not permanently incorporated into the finished Work are required to be furnished by a Contractor, a Subcontractor or a Materials and Equipment Supplier for performance of the Work. Existing Materials and Equipment may be required to be modified by Contractor or any Subcontractor in the performance of the Work.
- AA. “Material Supplier” and/or “Equipment Supplier” is a person, manufacturer, fabricator, supplier, distributor, materialman, vendor or entity retained by Contractor or with any subcontractor to provide Material and/or Equipment for incorporation into the Work and to provide other materials and/or equipment for performance of the Work.
- BB. “Milestone Date” is a principal event specified in the Contract Documents relating to an intermediate completion date or time prior to Substantial Completion of the entirety of the Work. If specified, Milestones may be subject to Liquidated Damages.
- CC. “Notice of Award” is the written notice issued by Thornton that awards the Work to Contractor.
- DD. “Notice to Proceed” is the written notice issued by Thornton to Contractor, which authorizes Contractor to commence performance of the Work and establishes the Commencement date which begins the contract time.
- EE. “Thornton’s Project Requirements” is the description of Thornton’s objectives that may include the purpose of the Project, budget and time criteria, performance requirements, special Equipment and systems, and Project Site requirements.
- FF. “Product Data” are illustrations, standard schedules, performance charts, cut sheets, instructions, brochures, diagrams and other information furnished by Contractor to illustrate Materials or Equipment for some portion of the Work.

- GG. "Project Site" means the place where the Work is to be constructed.
- HH. "Punch List" is the list of Work items contained in the Certificate of Substantial Completion that Contractor is required to complete or correct prior to Thornton granting Initial Acceptance.
- II. "Quality Assurance Testing and Inspection" is the testing and/or inspection performed under separate contract and paid for separately by Thornton to act as a secondary check on the quality of the Work on behalf of Thornton in evaluating whether Materials, Equipment, and/or workmanship complies with the quality requirements in the Contract Documents.
- JJ. "Quality Control Program" is a defined program outlining the procedures Contractor will follow to implement Quality Control Testing and Inspection.
- KK. "Quality Control Testing and Inspection" is the testing and/or inspection that Contractor performs to assure that all Materials, Equipment and workmanship have met the minimum standards for quality as defined in the Contract Documents.
- LL. "Record Documents" are Drawings, Specifications, Change Orders, Amendments, or other construction documents maintained by Contractor during the course of construction to show differing conditions and changes made to the original Contract Documents. May also be referred to as As-Built Drawings, Red Line Drawings and/or As-Built Specifications.
- MM. "Request for Information (RFI)" means a written request by Contractor directed to Thornton representative for a clarification of the information provided in the Contract Documents or for direction concerning information necessary to perform the Work.
- NN. "Right-of-Way" is a general term denoting land, property, or interest therein, acquired for or devoted to the construction of an improvement; may also be referred to as "ROW".
- OO. "Salvageable Material" is Material or Equipment that can be saved or salvaged for re-use.
- PP. "Samples" are physical examples which illustrate Materials, Equipment, and/or workmanship and establish standards by which the Work will be installed.
- QQ. "Shop Drawings" are drawings, diagrams, schedules and other data specially prepared for the Work by Contractor or a Subcontractor, Sub-subcontractor, manufacturer, supplier, or distributor to illustrate some portion of the Work.
- RR. "Special Conditions" are conditions which may supplement, enhance, differ from or supersede the terms and conditions of these General Conditions.

- SS. “Specifications” are that portion of the Contract Documents consisting of the written requirements for Materials, Equipment, construction, systems, standards, and workmanship for the Work, and performance of related Work. Organization of the Specifications into divisions, sections, and articles shall not control Contractor in dividing the Work among Subcontractors or in establishing the extent of Work to be performed by any trade. The Drawings may contain Specifications, and the Specifications may contain Drawings.
- TT. “Stop Work Order” is a written order issued by Thornton’s Contract Administrative Division to Contractor to suspend some or all of the Work under the Agreement; provided, however, that Work necessary to assure the safety and protection of persons and property shall continue to be the responsibility of Contractor unless otherwise directed by Thornton.
- UU. “Subcontractor” is a person or entity retained by Contractor or any tiered subcontractor (i.e. a sub-subcontractor) as an independent contractor to provide labor, Materials, Equipment, and/or services necessary to complete a specific portion of the Work or any other party supplying labor, equipment, and materials or only labor for Work under a separate contract or agreement with Contractor. The term does not include a Separate Contractor or a Separate Contractor’s subcontractors.
- VV. “Substantial Completion” is when the Work is sufficiently completed so it may be utilized by Thornton for the purposes for which it was intended, in accordance with applicable life, health, and safety codes, but excluding minor Work to be completed or corrected as Punch List Work.
- WW. “Thornton’s Representative” is the on-site representative assigned to the project by Thornton to observe the Work.
- XX. “Underground Facilities” are all underground pipelines, conduits, ducts, cables, wires, manholes, vaults, tanks, tunnels, or other such facilities or attachments, and any encasements containing such facilities, including those that convey electricity, gases, steam, liquid petroleum products, telephone, fiber optics, or other communications, cable television, water, wastewater, storm water, other liquids or chemicals, or traffic or other control systems.
- YY. “Unit Price Work” is work to be paid for on the basis of unit prices.
- ZZ. “Warranty Correction Period” means the period from Initial Acceptance to Final Acceptance during which Contractor is responsible for correcting defects or non-conforming Work and to keep the Work in good repair. May also be referred to as Warranty Period.

AAA. "Work" is the construction, supervision, any Additional Work that may be requested by Thornton, Warranty Correction Period services, and other services which are necessary to complete Contractor's obligations and complete the Project in accordance with and reasonably inferable from the Contract Documents. The Work, whether completed or partially completed, includes all labor, Materials, Equipment, and services provided or to be provided by Contractor.

II. THORNTON'S ROLE, RESPONSIBILITIES

A. Separate Contractors

1. The term "Separate Contractor(s)" are other contractors hired by Thornton and working under another agreement(s). Thornton reserves the right to perform construction or operations related to the Project with Thornton's own forces or with Separate Contractors in connection with other portions of the Project, or other construction or operations on the Project Site, under terms and conditions substantially similar to this Agreement, including those terms and conditions related to insurance and waiver of subrogation. When applicable, and at Thornton's discretion, Thornton may notify Contractor after execution of any separate contracts.

B. Thornton's Representative

1. Thornton's Representative will furnish the information and services required of Thornton in a timely manner. Thornton's Representative, however, shall not independently have the authority to sign or authorize Change Orders. If Thornton changes its representative or the representative's authority as described above, Thornton shall notify Contractor in writing. Thornton's Representative is placed on the Project Site to observe the Work and to keep Thornton informed as to the progress of the Work and the manner in which the Work is being performed, to keep records, to act as liaison between Contractor and Thornton, to call to the attention of Contractor any Defective Work or deviations from the Contract Documents and to reject Defective Work.
2. Because one of Thornton's Representative's primary obligations is to assure that the Work progresses expeditiously and in a good and workmanlike manner, Thornton's representative may offer suggestions to Contractor, which Contractor may or may not accept, at its discretion. Such suggestions are never to be considered as anything but suggestions and involve no assumption of responsibility, financial or otherwise, by either Thornton or Thornton's Representative. In carrying out any of the provisions of the Contract Documents or in exercising any power or authority granted thereby, there shall be no liability upon Thornton's Representative, either personally or as an official of Thornton, it being understood that in such matters, they act as an agent and representative of Thornton only.

3. Any assistance that Thornton's Representative may give Contractor shall not be construed as the basis of any assumption of responsibility or liability in any manner, financial or otherwise, by Thornton's Representative or Thornton. If any part of Contractor's Work depends upon the work of any other contractor for the proper execution or results, Contractor shall inspect and promptly report in writing to Thornton any lack of progress or defects in the other contractor's work as fit and proper for the reception of Contractor's Work. No extensions to the Contract Time will be granted to the Contractor to inspect and report on unsuitable work.
4. Thornton's Representative is not and does not purport to be a safety engineer and is not engaged in that capacity by Thornton and shall not have the responsibility to enforce safety Laws, rules, regulations or procedures, nor shall they be responsible for the safety of persons on and about the Project Site.
5. The presence or absence of Thornton's Representative's on the Project will be at the sole discretion of Thornton, and such presence or absence of Thornton's Representative will not relieve Contractor of its sole responsibility to obtain the results required by the Contract Documents.
6. Thornton's Representative shall not be authorized to approve or accept any portion of the Work or to issue instructions contrary to the Contract Documents. Such approvals, acceptance, or instructions, if given, must be in a fully executed Change Order. Thornton's Representative shall have authority to reject Defective Work; however, the failure of Thornton's Representative to reject Defective Work or Work that deviates from the Contract Documents shall not constitute acceptance of such Work by Thornton.
7. Nothing in this Section shall in any way be construed so as to require or to place responsibility for the method, manner, scheduling, coordination, or supervision of the Work upon Thornton's Representative or Thornton. Such responsibility rests solely with Contractor.

III. CONTRACTOR'S ROLE, RESPONSIBILITIES

- A. Contractor's Representation. Contractor represents it has the appropriate resources, experience, and knowledge to perform the Work required to construct the Project.
- B. Right of Entry. Contractor shall provide to Thornton, Thornton's Representative, and representatives of federal, state, county, district and municipal governments complete and free access to the Work, whenever requested.
- C. Supervision.
 1. Contractor shall supervise and direct the Work, using Contractor's best skill and attention. Contractor shall be solely responsible for, and have control

over, construction means, methods, techniques, sequences and procedures, and for coordinating all portions of the Work under the Contract Documents unless Contract Documents give other specific instructions concerning such matters.

2. In the event a conflict or ambiguity exists within the Contract Documents, Contractor shall notify Thornton and resolve such ambiguity to include the highest quality and largest quantity.

- D. Performance of Work. Work that has not been given Initial Acceptance by Thornton remains in the sole control of Contractor until the entirety of the Work is complete. Because Thornton cannot control how Contractor performs the Work, the responsibility for safety and proper use shall be the Contractor's sole responsibility. Until the entirety of the Work is completed, Contractor may perform Work that changes or modifies Work previously done, and even though at any given time, a portion of Work might be complete and acceptable in quality, the responsibility for keeping it in that condition until all of the Work is complete, is the sole responsibility of Contractor. For this reason, Thornton will not accept any portion of the Work until the entirety of the Work is complete and control of the Work is withdrawn from Contractor by Initial Acceptance by Thornton, unless otherwise agreed upon and stated in the Agreement.
- E. Personnel\Subcontractors. If, during the term of this Agreement, Thornton determines that the performance of Contractor's personnel or Subcontractor(s) is not acceptable, it will notify Contractor and provide Contractor with the time by which Thornton considers reasonable to correct such performance. If Contractor fails to correct such performance of its personnel or subcontractor(s) to Thornton's satisfaction, Thornton may take any necessary actions to remedy the situation. If necessary, Contractor shall obtain adequate substitute personnel and/or Subcontractors(s) at Contractor's expense until acceptable permanent replacement personnel and/or Subcontractors can be implemented.
- F. Materials, Equipment and Supplies. Contractor shall provide and pay for all labor, Materials, Equipment, tools, Construction Equipment and machinery, water, heat, utilities, transportation, and other facilities and services necessary for proper execution and completion of the Work, whether temporary or permanent, and whether or not incorporated or to be incorporated in the Work.
- G. Tests, Inspections. Contractor shall, after execution of this Agreement and receipt of Notice to Proceed, undertake all such testing, inspections, evaluations, and investigations necessary to perform its obligations under the Contract Documents. All documentation, reports and analyses generated by Contractor's testing, inspections, evaluations, and investigations, including, but not limited to, additional testing shall be promptly furnished to Thornton.

H. Ingress and Egress onto Private and Public Property, Facilities.

1. Contractor shall insure that private property owners' access from the street or alleyway to their private property is not restricted except during limited times during normal working hours. When access to a private property cannot be continuously maintained during normal working hours, Contractor must obtain permission from Thornton for temporary closures and shall personally provide written and verbal notice to the affected property owner a minimum of twenty-four (24) hours in advance of the closure. Emergency vehicle access shall not be blocked at any time for any reason.
2. Contractor shall contact any property owner verbally and in writing where access across their property is needed to perform the Work or access the Project Site.
3. Contractor shall assure that safe access to public facilities is provided. Any disruption to the public's normal use of such facilities shall not occur without the express written permission of Thornton.

I. The CPM Schedule

1. CPM Schedule. Prior to commencing construction, within thirty (30) Days following Notice to Proceed, Contractor shall develop a detailed critical path method schedule ("CPM Schedule") using either Primavera, Microsoft Project or approved equal scheduling software. The CPM Schedule shall be updated with each Application for Payment to reflect the actual progress of the Work and changes in the CPM Schedule. The CPM Schedule shall be used to plan, organize, control and execute the Work and forecast remaining Work. Contractor shall assure that all Subcontractor and Sub-subcontractor Work, and acquisition and delivery of Materials and Equipment, as well as its own Work, are included in the CPM Schedule and that the CPM Schedule represents a coordinated plan of Work.
2. Milestone Dates. The CPM Schedule shall include Milestone Dates, if any, and shall indicate the commencement and completion dates of the various activities of the Work, including the dates when information and approvals are required from Thornton. Submittal of the CPM Schedule to Thornton shall not indicate approval by Thornton of any changes in the Contract Time. Adjustments in the Contract Time require an executed Change Order.
3. CPM Schedule Details. The CPM Schedule shall clearly show the critical path or paths, Milestone Dates, if any, Substantial Completion Date, procurement, fabrication and construction activities, Shop Drawing and Sample preparation, submittal review and approval activities, activity numbers, descriptions and durations, activity start and finish dates, specified phasing and sequencing requirements, and the proposed sequence and logic ties of activities required for the orderly performance and completion of all elements of the Work, along with the resources

necessary for completion of each activity. Activity durations shall be in Days and, in general, shall not be less than one (1) Day. Seasonal weather conditions, holidays, long lead time procurements and other contingencies shall be considered in planning and scheduling the Work.

4. CPM Format. The CPM Schedule shall be accompanied by computer printouts, which illustrate:
 - a. Planned progress (by Work Day) for each pertinent activity, as well as for the overall Work during the period of performance;
 - b. The shift and work week basis for each activity if other than on a single shift basis, five (5) Days per week (Monday through Friday, holidays excluded), eight (8) hours per Day;
 - c. Predecessor and successor activities for each activity, as well as lag relationships and durations;
 - d. Early start, early finish, late start, late finish and total float for all activities;
 - e. Any Milestone Dates;
 - f. Drawings, permits and/or other information required from Thornton, with specified time limitations;
 - g. Interfaces with the work of Separate Contractors, with specified time limitations; and
 - h. Activities comprising the primary and secondary paths of criticality on the schedule.

5. CPM Schedule Updates Required. Contractor shall monitor the CPM Schedule on a weekly basis and update it on at least a monthly basis to incorporate actual start and finish dates, to record actual progress achieved during the reporting period and to provide a more accurate schedule of the next month's Work. A printed copy, as well as an electronic copy (PDF or an approved alternative format) of each updated CPM Schedule shall be submitted to Thornton with Contractor's Applications for Payment and shall be accompanied by a written narrative, which shall include:
 - a. A description of all activities or portions of activities completed during the reporting period, along with the completion dates;
 - b. A description of planned and actual dates for activities started during the reporting period;

- c. The status of each activity along the critical and near-critical paths in terms of Days ahead or behind the scheduled dates;
 - d. A description of all Change Orders with an explanation of activities added or deleted, activities impacted, and extent of the impact(s) caused by each Change Order;
 - e. A description of all delaying events, if any, with an explanation of activities added or deleted, activities impacted, and the extent of the impact(s) caused by each delaying event;
 - f. A description of any revisions (including the basis or rationale for those revisions) to the schedule logic or sequencing, activity durations and/or staffing requirements for the reporting period; and
 - g. Identification of activities that are behind schedule, a description of any problem areas in the schedule as well as any current and anticipated delaying factors and their impacts and any remedial actions taken or proposed to assure completion of the Work within the Contract Time.
6. Notwithstanding any of the foregoing provisions to the contrary, all CPM Schedules and updates are subject to Thornton's review and approval. Thornton's approval will be only to determine if the Work conforms to the information given in the Contract Documents and is compatible with the Project as a whole. Thornton's review and approval shall not relieve Contractor of its responsibility for the performance of the Work in accordance with the Contract Documents. Approval of a schedule showing work beyond a milestone date does not relieve the Contractor of Liquidated Damages for not meeting that date.
7. Contractor shall coordinate with other entities (i.e. utilities, permitting agencies, etc.) as necessary to complete the Project and adjust their construction schedules as necessary for the completion of the Work. Contractor shall make revisions to the Schedule as deemed necessary after a joint review and upon mutual agreement by affected parties.

J. Contractor's Personnel and Subcontractors.

1. Contractor's Representative. Contractor shall employ a competent superintendent and necessary assistants who shall be in attendance at the Project Site at all times during the performance of the Work. The superintendent shall represent Contractor, and communications given to the superintendent shall be as binding as if given to Contractor. Important communications shall be confirmed in writing. Other communications shall be similarly confirmed on written request.

2. Contractor's Personnel.

- a. Contractor shall be responsible to Thornton for acts and omissions of its employees, Subcontractors and their agents and employees, and all other persons performing portions of the Work for Contractor. Contractor shall enforce strict discipline and good order among its employees, Subcontractors and all other persons performing the Work. Contractor shall not permit employment of unfit persons or persons not skilled in tasks assigned to them.
- b. Contractor shall be liable to Thornton for losses, costs and expenses attributable to any acts or omissions by Subcontractors, and their agents and employees resulting from the failure to comply with Laws, including, fines, penalties and corrective measures.

3. Independent Contractor.

- a. It is understood and agreed by and between the Parties that the status of Contractor shall be that of an independent contractor and a person retained on a contractual basis to perform construction Work for a limited period of time and it is not intended, nor shall it be construed, that Contractor is an employee or officer of Thornton under Chapter VII of the Thornton City Charter, or Charter 54 of the Thornton City Code, or for any purpose.
- b. Neither Contractor nor any of its agents or employees shall act on behalf of or in the name of Thornton unless authorized in writing by Thornton.
- c. The Parties acknowledge that **Contractor is not entitled to unemployment insurance benefits unless unemployment compensation coverage is provided by Contractor or some other entity besides Thornton, that Contractor is not entitled to Workers' Compensation benefits from Thornton, and that Contractor is obligated to pay federal and state income tax on any monies earned pursuant to this Agreement.**

4. Subcontractors, Suppliers, and Others

- a. Work not self-performed by Contractor shall be performed by Subcontractors under written agreements with Contractor.
- b. Before entering into contracts with Subcontractors, Contractor shall submit a list of proposed Subcontractors for Thornton to review. Contractor shall not contract with any Subcontractor to whom Thornton has made reasonable objection. Thornton may propose Subcontractors to be considered by Contractor. Contractor,

however, shall not be required to retain any Subcontractor to whom Contractor has made reasonable objection.

- c. Thornton reserves the right to request Contractor to submit the qualifications and resumes of proposed key staff of its proposed Subcontractors for Thornton's review and approval.
 - d. All Work performed for Contractor by each Subcontractor or Supplier will be pursuant to an appropriate agreement between Contractor and Subcontractor or Supplier specifically binding Subcontractor and Supplier to the applicable terms and conditions of the Contract Documents for the benefit of Thornton.
5. Agreements with Subcontractors shall not create any obligation on the part of Thornton to pay or to see to the payment of any moneys due any such Subcontractor, Supplier, or other individual or entity and must contain a valid and binding provision whereby the Subcontractor waives any and all rights to make a claim against Thornton (other than a Verified Statement of Claim against the contract funds) arising out of the performance of the Work.
- a. Contractor shall be solely responsible for the supervision and management of Subcontractors in the performance of their Work throughout the Project including the Warranty period.
 - b. Nothing contained in the Contract Documents shall create any contractual relationship between any Subcontractor and Thornton.
 - c. Each subcontract agreement shall contain a clause that allows Contractor to terminate Subcontractor if Subcontractor is or has been debarred in accordance with applicable local, state and federal laws.
- K. Materials and Equipment. Contractor shall provide and pay for all labor, Materials, Equipment, tools, Construction Equipment and machinery, water, heat, utilities, transportation, and other facilities and services necessary for proper execution and completion of the Work, whether temporary or permanent, and whether or not incorporated or to be incorporated in the Work.
- L. Stockpiling and Storage of Material or Equipment.
- 1. Contractor shall not stockpile Materials or store Equipment or Construction Equipment in the public streets or ROW, except for that which is expected to be used that day unless permanent traffic control is allowed, and the stockpile is approved in advance in writing by Thornton. If Material is stockpiled for use that day, Contractor shall utilize proper traffic control and necessary barricades. At all times, Contractor shall provide access to adjacent properties by individual occupants and visitors, as well as

necessary services they may require (e.g., mail service, trash collection, snow plowing, etc.).

2. All operations of Contractor, including storage of Materials, Equipment and Construction Equipment shall be confined to areas authorized by Thornton. Contractor shall be liable for any and all damages to such areas resulting from its occupancy.
3. Contractor shall be responsible for the care, compliance with Laws and storage of Materials or Equipment delivered to the Project Site or purchased for use thereon. Stored Materials or Equipment shall be carefully and continuously protected from theft, damage or deterioration and located so as to facilitate inspection by Thornton. The responsibility for the care and storage of Materials or Equipment shall be Contractor's whether such Materials or Equipment are furnished by Contractor or by Thornton. Storage of Materials or Equipment shall not unduly interfere with the progress of the Work or the work of any Separate Contractor.
4. To the fullest extent permitted by law, Contractor shall defend, indemnify, and hold harmless Thornton from liability of any nature or kind arising from any use, trespass, or damage caused by its operations on any private property.

M. Warranty of Materials, Equipment.

1. Contractor warrants that all Materials and Equipment furnished as part of the Work shall be new unless otherwise specified, of good quality, in conformance with the Contract Documents, and free from defective workmanship and Materials. In the absence of detailed Specifications, all Materials and Equipment shall conform to the latest standards of the American Society for Testing and Materials (ASTM). Work not conforming to these requirements, including substitutions not properly approved and authorized, may be considered defective.
2. Contractor shall collect all written manufacturer's warranties and certificates and deliver them to Thornton at a time and in a format directed by Thornton. All written warranties shall be submitted to Thornton as a condition precedent to granting Initial Acceptance of the Work.
3. The Warranty Correction Period during which Defective Work must be corrected shall commence on the Date of Initial Acceptance.

N. Licenses And Permits

1. Contractor shall obtain, at its expense, all appropriate licenses from Thornton and/or other governing jurisdictions before the start of construction. A Master Plumber's License is required to connect to water

and sanitary sewer mains in the City of Thornton. Costs associated with obtaining a Master Plumber's License are the sole responsibility of Contractor.

2. Unless otherwise specified or indicated, all permits necessary for construction of the Work, including federal, state, county, and local permits shall be obtained by and paid for by Contractor.
3. Contractor shall obtain all required applicable permit(s) before commencing any construction.
4. Building Permits for construction within the Thornton City limits are obtained from the City of Thornton, City Development Building Inspection Division, located at 9500 Civic Center Drive, Thornton, CO 80229. Construction Permits for construction within the Thornton City limits are obtained from the City of Thornton, Infrastructure Department Streets Division, located at 12450 Washington Street, Thornton, CO 80241. Traffic Control permits for construction work, oversized loads, or deliveries blocking the Right-of-Way within the Thornton City limits are obtained from the City of Thornton, Infrastructure Department Traffic Division, located at 12450 Washington Street, Thornton, CO 80241. There is no charge to Contractor for these City of Thornton permits. **All three types of permits shall be applied for on-line through Thornton's website.**
5. Contractor shall obtain a Stormwater Discharge Permit as required by the CDPHE for construction sites to the extent that it is required. Contractor will work cooperatively and in accordance with the guidelines set forth by Thornton's Stormwater Department.
6. Contactor shall provide copies of all permits to Thornton's Construction Manager throughout the entire Project.

IV. PROJECT INFORMATION, SUBMITTALS, RECORD DOCUMENTS

A. Project Information.

1. Thornton shall provide Contractor information to the extent it is in Thornton's possession and control and deemed necessary by Thornton to perform the Work.
2. To the extent there is any Thornton-provided information, Thornton makes no representation or warranty as to the accuracy of Thornton-provided information. Contractor shall carefully study and compare all Thornton-provided information with field conditions, as well as for the internal consistency of such information, and shall promptly report in writing (through an RFI) to Thornton any conflict, ambiguity, or discrepancy which Contractor may discover and shall obtain a written interpretation or clarification from Thornton before proceeding with any Work affected thereby.

B. Submittals.

1. Shop Drawings, Product Data, Samples and similar submittals are not Contract Documents. The purpose of these submittals is to demonstrate for those portions of the Work for which submittals are required the way Contractor proposes to conform to the information given and the design concept expressed in the Contract Documents.
2. Contractor shall review, approve and submit to Thornton, Shop Drawings, Product Data, Samples and similar submittals required by the Contract Documents with reasonable promptness and in such sequence as to cause no delay in the Work or in the activities of Thornton or of Separate Contractors. Submittals made by Contractor which are not required by the Contract Documents may be returned without action.

C. Certification of Submittals.

1. By approving and submitting Shop Drawings, Product Data, Samples and similar submittals, Contractor represents that it has determined and verified Materials, Equipment, field measurements and field construction criteria related thereto, or will do so, and has checked and coordinated the information contained within such submittals with the requirements of the Work and of the Contract Documents and that all data shown on the submittals are complete and accurate. Contractor shall not be relieved of responsibility for errors or omissions in Shop Drawings, Product Data, Samples or similar submittals, by Thornton's approval.
2. When professional certification of performance criteria of Materials, systems or Equipment is required by the Contract Documents, Thornton shall be entitled to rely upon the accuracy and completeness of such certifications.

D. Submittal Schedule.

1. Prior to the submission of any submittals, Contractor shall submit a detailed Submittal Schedule for Shop Drawings, Product Data, Samples, mock-ups, calculations, and other required submittals, which shall list each required submittal per the Contract Documents, the proposed date for Contractor's initial submittal, the proposed date for Thornton's completion of the initial review, and the current status of each submittal showing whether pending, in review, rejected, resubmitted or approved for Thornton's approval, which shall not unreasonably be delayed or withheld. This Submittal Schedule shall be consistent with the CPM Schedule for completion of the Work. All submittals shall be submitted to Thornton for review and approval in accordance with this Submittal Schedule. Contractor shall update the Submittal Schedule at a minimum on a bi-weekly basis until such time as all submittals have been approved.

2. The Submittal Schedule shall:
 - a. Be coordinated with the CPM Schedule;
 - b. Allow Thornton reasonable time to review submittals and in accordance with the time specified in the Special Conditions; and
 - c. Be periodically updated to reflect the progress of the Work.
3. Contractor shall direct specific attention, in writing or on resubmitted Shop Drawings, Product Data, Samples or similar submittals, to revisions other than those requested by Thornton on previous submittals.
4. All submittals shall be submitted to Thornton in electronic format whenever possible. When electronic submittals are not possible, a minimum of four (4) copies of the submittal shall be provided.
5. Submittals shall be accompanied by a letter of transmittal which shall list submittal numbers and dates of the submittal and shall be in the form approved by Thornton. Hard copy submittals shall be bound in sets. Any resubmittals shall show submittal and resubmittal numbers as well as the dates for previous submittals and resubmittals.
6. Submittals shall be marked with the name of the Project and submittal number and bear the stamp or specific written indication of approval of Contractor as evidence that the submittal has been checked and approved by Contractor. Any submittal without Contractor's stamp of approval or specific written indication of approval shall not be considered by Thornton and shall be returned to Contractor for their approval and resubmission.
7. Each submittal shall give notice to Thornton of any variation between the submittal and the requirements of the Contract Documents. Contractor shall place a specific notation on the submittal and call such variation to Thornton's attention in the letter of transmittal. If the variation as submitted is acceptable, Thornton will provide written approval of the variation to Contractor. Thornton's review and approval of submittals shall not relieve Contractor from responsibility for strict compliance with the requirements of the Contract Documents, unless Contractor has, in writing, called Thornton's attention to each variation at the time of submission, as required above, and Thornton has given unconditional written approval of each variation to the Contractor.
8. Submittals not conforming to the above requirements shall be returned to Contractor, without action by Thornton, for resubmittal. Any resulting delay shall be the sole responsibility of Contractor.

E. Operations and Maintenance Manuals.

1. Submittals of Operations and Maintenance (“O&M”) Manuals shall initially be made in electronic format for review and comment by Thornton. O&M Manuals shall include detailed manufacturer’s information on all operations and maintenance recommendations, replacement parts lists, and assembly diagrams.
2. Upon approval of the O&M Manuals, four (4) sets of hardcopies bound in ring binders, along with an updated electronic file, shall be furnished by Contractor to Thornton. In the bound hardcopies, frequently referenced pages, such as maintenance schedules, parts lists and assembly diagrams, shall be inserted into plastic sleeves or laminated for protection.
3. All finalized O&M Manuals shall be furnished to Thornton as a condition precedent to Initial Acceptance.

F. Record Documents (“As-Built Drawings\Specifications”)

1. Throughout construction, Contractor shall maintain a thorough up-to-date record of all changes to the Drawings, Specifications and other Contract Documents made during construction. As a condition precedent to granting Initial Acceptance, Contractor shall file with Thornton one (1) complete set of redlined Record Documents showing all changes and including Contractor’s field construction notes neatly and legibly recorded thereon. Such changes shall include, but not be limited to, the exact routing if changed from Drawing location of sewer, water, gas, oxygen supply, condenser water lines, fuel oil tanks and lines, fire protection lines, and any other buried utility lines, and routing of buried electrical feeder lines and changes to routing of conduit runs which are buried or concealed.
2. Record Drawings shall be submitted on in electronic CAD format compatible with Thornton’s CAD system. The title block shall indicate “Record Documents” and be dated as of the Date of Initial Acceptance. All Drawing changes shall be circled with a “cloud” and any applicable Change Order or Amendment number shall be included in a “delta” adjacent to the cloud and recorded in the title block.
3. All other Record Document changes including, but not limited to, Agreement and Specification changes, shall be provided in both a bound hardcopy and in Microsoft Word format on an electronic storage device approved by Thornton. Changes shall be indicated by striking through deleted information and adding revised information in italics. Any applicable Change Order or Amendment number shall be indicated in parentheses immediately following the changed text. Applicable indices shall indicate those sections containing revisions by denoting these sections with an asterisk (*) and including a footnote that states “*Revised.”

4. At the conclusion of construction and as a condition precedent to Thornton granting Initial Acceptance, Contractor shall prepare and submit to Thornton:
 - a. Redlined field set of Record Drawings;
 - b. Redlined field set of Record Specifications;
 - c. Data in electronic format that document how the various elements of the Work, including changes, were constructed or installed;
 - d. Written consent from Surety to release Final Payment to Contractor;
 - e. Training, if required, along with documentation of same; and
 - f. Operations and maintenance manuals.

V. PROJECT AND CONSTRUCTION MANAGEMENT

- A. Construction Progress Meetings. Construction progress meetings shall be conducted by the Contractor weekly at time and location mutually agreed to by the Parties and shall include, but not be limited to, discussion of the following items:
 1. Work completed since the prior meeting;
 2. CPM Schedule status and near term look ahead schedule;
 3. Submittal schedule and status report, including a summary of outstanding submittals;
 4. Requests for Information status;
 5. Approved Change Orders since prior meeting;
 6. Pending Change Order status;
 7. Tests and inspection results since prior meeting;
 8. Problems requiring Thornton's input for resolution;
 9. Status report of Work rejected by Thornton;
 10. Additional information as agreed to by Thornton and Contractor; and
 11. Contractor shall maintain logs and Project controls for tracking the above items and shall make copies available to Thornton and other attendees at each construction progress meeting.

B. Daily Site Report. Contractor shall prepare a Daily Site Report for each Day that Work occurs or is scheduled to occur, including inclement weather days, and shall submit them to Thornton on at least a weekly basis. If Contractor fails to comply with this requirement, Thornton may reject any pending Application for Payment until Contractor submits all reports that are due. The report shall, at a minimum, describe:

1. Type(s), location(s), quantity(s), and progress of Work performed;
2. On-site labor for craftsman by craft, Subcontractor, supervision, and office personnel, with activities performed, number of personnel and hours worked on each activity;
3. Construction Equipment (number, type, and time) utilized on-site and for which activities;
4. Type(s) and quantity(s) of Material and Equipment incorporated into the Work;
5. Unanticipated problems encountered;
6. Climatic data (temperature, precipitation, wind) for morning and afternoon;
7. Accidents;
8. Damage to in-place Work;
9. Materials or Equipment received at the Project Site;
10. Results of any testing;
11. Any unforeseen conditions;
12. Standard Work Days not worked for any reason, including but not limited to; weather, labor shortage, delays, equipment and or material shortage; and
13. Other notable events.

C. Safety Program.

1. Contractor shall have sole responsibility for initiating, maintaining and supervising safety precautions and safety programs and compliance with Laws in the performance of the Work provided that such obligation does not relieve Subcontractors of their responsibilities for the safety of persons or property in the performance of their Work or for compliance with safety Laws and regulations.

2. Upon request, Thornton has the right to review Contractor's, and its Subcontractors' safety policies, procedures, standards and documentation of training ("Safety Program"). Thornton's review does not suggest nor involve an assumption of responsibility or liability, financial or otherwise, by either Thornton or Thornton's Representative.
3. Contractor shall designate a qualified and experienced individual at the Project Site in its employ who shall act as Contractor's designated safety representative with the duty to prevent incidents and accidents and the maintaining and supervising of safety precautions and programs to prevent injury, loss or damage to persons or property.
4. Contractor shall seek to avoid injury, loss or damage to persons or property by taking all necessary steps to protect:
 - a. Its employees and all persons on the Project Site or who may be affected by the Work;
 - b. Materials, supplies and equipment whether in storage on or off the Project Site; and
 - c. The Project and all property and structures located at the Project Site and adjacent to Work areas, including trees, shrubs, lawns, walks, pavements, roadways, structures, utilities, and Underground Facilities not designated for removal, relocation, or replacement in the course of construction whether or not such property or structures are part of the Project or involved in the Work.
5. Contractor shall at all times:
 - a. Safely guard Thornton's property and abutting or adjacent property from injury, loss, or damage;
 - b. Protect by false work, braces, shoring or other effective means all buildings, foundations, walls, fences, and other property along its line of Work, or affected directly by its Work including, but not limited to, Thornton's property, against damage;
 - c. Provide, erect, and maintain suitable barriers around all excavations or obstructions to prevent incidents, and provide, place, and maintain during the night sufficient lights, signals, and signs for this purpose on or near the Work;
 - d. Cover or otherwise protect stockpiles of Materials to avoid damage to the Materials and damage to any property from such Materials;
 - e. Protect all Work affected by inclement weather using professional judgment and best work practices to ensure proper execution of the Work and to avoid or prevent weather-related damage;

- f. Repair, replace, or remedy any damage, loss or injury, unless caused directly by Thornton except as outlined herein; and
 - g. Protect the general public from the construction site.
 - 6. In any emergency affecting the safety of persons or property, Contractor shall take reasonable measures to prevent any damage, injury or loss. Any change in the Contract Price or the Contract Time on account of emergency Work shall be determined as provided for herein.
 - 7. If Thornton determines that any part of the Work or Project Site contains safety hazards that have reached an unacceptable level of risk, Thornton, without assuming responsibility for Contractor's safety program, may require Contractor to stop the Work immediately and take corrective measures that are satisfactory to Thornton. If Contractor does not promptly institute corrective measures, Thornton may perform them. The cost of such corrective measures performed by Thornton shall be the sole responsibility of the Contractor. Upon receipt of the invoice from Thornton, Contractor shall pay all costs incurred by Thornton or Thornton will deduct the costs from any funds owed and due to Contractor. The performance of any corrective work by Thornton shall not relieve Contractor of its responsibility for all the damage caused by Contractor, any Subcontractor, Supplier, or any other individual or entity directly or indirectly employed by any of them to perform any of the Work, or anyone for whose acts any of them may be liable because of any corrective action taken by Thornton.
- D. Uninsured Damage, Loss by Contractor and Subcontractors. Any uninsured damage or loss caused by Contractor while performing any Work, shall be repaired and paid for by Contractor. Likewise, any uninsured damage or loss caused by any Subcontractor or person acting on Contractor's behalf, while performing any Work, shall be repaired and paid for by Contractor. Upon receipt of any claim for uninsured damage or loss, Thornton will forward the claim to Contractor. All uninsured damage or loss to such property caused by Contractor and its Subcontractors shall be the sole responsibility of Contractor, and Thornton shall not compensate Contractor as a result.
- E. Project Site Maintenance.
 - 1. Contractor shall regularly remove debris and waste from the Project Site and keep all ROW streets, alleys, sidewalks and other premises free from material and debris as the character of the Work will permit. Thornton may direct Contractor to provide immediate clean-up of the Project Site and Contractor shall comply. Prior to discontinuing Work in an area, Contractor shall clean the area and remove all rubbish, Construction Equipment, tools, machinery, waste and surplus Materials. Contractor shall take all necessary efforts to minimize and confine dust and debris resulting from construction activities. Under no circumstances shall Contractor allow any condition to exist which creates a nuisance, fire hazard or an environment injurious to health or safety.

2. If Contractor fails to comply with this section, after notice has been given by Thornton, Thornton shall have the right to remove all rubbish, Construction Equipment, tools, machinery, waste and surplus Materials and to withhold the actual costs from any funds owed or due to Contractor or if no funds are available, will submit an invoice to Contractor for payment which Contractor shall promptly pay.
- F. Salvage Material. Materials designated as salvageable on the Drawings or in the Specifications shall be carefully removed from the Project Site, delivered, and unloaded by Contractor in good condition to a storage location as directed by Thornton.
- G. Waste Disposal.
1. Contractor shall be solely responsible for locating legal disposal and dumpsites and making arrangements for disposal of all material removed from the Project Site. This includes concrete, asphalt, unsuitable or unstable trench material, and any other trash, rubbish, or debris generated as a result of the construction of the Work. Asbestos or other hazardous materials will be disposed of in accordance with any and all applicable laws and regulations. The Contractor shall promptly submit copies of the disposal manifests to Thornton to demonstrate proper disposal of all materials.
 2. At the completion of the Work, Contractor shall remove from the Project Site all Construction Equipment, tools, surplus Materials, waste and debris.
- H. Potentially Dangerous Work.
1. When the use of explosives, driving, or removal of piles, wrecking, excavation or other similarly potentially dangerous activities are necessary for the performance of the Work, Contractor shall exercise the utmost care so as not to endanger health, life or property. Contractor shall be solely responsible for any and all damages, claims, and for the defense of any actions against Thornton resulting from such potentially dangerous activity, including payment of attorneys' fees, and if Contractor is found to have not followed the industry standard of care in performing such operations, any costs for damages resulting therefrom shall not be compensated.
 2. Contractor shall notify each public utility company or other owner of private property having structures or improvements in proximity to the Project Site of its intent to perform potentially dangerous activities. Such notice shall be given sufficiently in advance to enable the companies or owners of property to take such steps as they deem necessary to protect their property.
 3. All explosives shall be stored in a secure manner and all storage places shall be marked clearly "EXPLOSIVES - KEEP OFF" and shall be in the care of competent watchmen at all times.

I. Hazardous Material.

1. After commencing the Work, if previously unknown suspected Hazardous Material is discovered at the Project Site, Contractor shall immediately stop Work in the area affected by the presence of the suspected Hazardous Material. Contractor shall immediately report the condition to Thornton and, if required, any governmental agencies with jurisdiction. Contractor shall not commence or continue Work until any existing known or unknown Hazardous Material at the Project Site has been remediated or rendered harmless, unless such Work is included in the Contractor's scope of Work.
2. Thornton may retain or direct Contractor to retain an environmental consultant to determine the nature of the suspected Hazardous Material encountered and whether it is a Hazardous Material requiring corrective measures or remedial action.
3. Thornton may retain a Separate Contractor to take such measures or actions to remediate or render harmless any previously known or unknown Hazardous Material, or Thornton may add such measures or actions to the Contractor's scope of Work by written Amendment or Change Order. Such measures or actions shall be performed in a manner minimizing any adverse effect upon the Work.
4. Except for authorized corrective measures or remedial actions, Contractor shall resume Work in the area affected by any Hazardous Material only upon written agreement between the Parties after the Hazardous Material has been removed or rendered harmless and only after approval of governmental agencies with jurisdiction.
5. Contractor shall modify to the extent possible the Work activities and/or CPM Schedule to minimize any negative impact to the progress of the Work or to the Contract Price.
6. If Contractor incurs additional costs or Work on the Contractors Critical Path is delayed due to the presence of, remediation of, or rendering harmless any Hazardous Material that was unforeseen when the Contract was executed, Contractor may be entitled to an adjustment in the Contract Price and/or the Contract Time.
7. Safety Data Sheets (SDS) as required by law and pertaining to Materials or substances used or consumed in the performance of the Work, whether obtained by Contractor, Subcontractors, Thornton or others, shall be maintained at the Project Site by Contractor and made available to Thornton upon request.
8. During Contractor's performance of the Work, Contractor shall be solely responsible for the proper handling, installation and disposal of all Materials and substances brought to the Project Site by Contractor, including Hazardous Material.

9. Asbestos, lead, or other Hazardous Materials shall be disposed of in accordance with any and all applicable Laws and regulations. Contractor shall promptly submit copies of the disposal manifests to Thornton to demonstrate proper disposal of all Hazardous Materials.

J. Project Site Staging Area.

1. Contractor shall make every effort to contain its operations to the smallest area possible. All areas which have been disturbed shall be returned to their original grade and condition, or better.
2. Contractor is solely responsible for acquisition and payment for any staging area to be used during construction over and above any staging area(s) within the Project Site. This area shall be secure to prevent loss of Materials and Equipment. Any replacement of lost or damaged (including vandalism) Materials and/or Equipment shall be the responsibility of Contractor and shall not be compensated.
3. All operations of Contractor, including storage of Materials, Equipment, and Construction Equipment shall be confined to the area or areas authorized by Thornton. Contractor shall be liable for any and all damages to such premises resulting from its occupancy.

- K. Sanitary Facilities. Contractor shall furnish the necessary sanitary conveniences for its employees and others at the Project Site, properly secluded, for use during construction. These conveniences shall be maintained in a manner that will be inoffensive and in compliance with federal, state, and local health and sanitation requirements. Contractor's employees, Subcontractors, Sub-subcontractors, and suppliers shall not use Thornton's restrooms unless prior authorization has been granted by Thornton in writing.

**VI. QUALITY ASSURANCE AND QUALITY CONTROL, THORNTON
INSPECTION OF WORK**

- A. Quality Control is the responsibility of the Contractor.

B. Quality Assurance Tests, Inspections.

1. Notice Required. During construction, the Work shall be subject to the review and observation of Thornton. Contractor shall afford every reasonable facility and assistance to Thornton to review, observe, inspect and test the Work as required by Thornton's Quality Assurance ("QA") program. QA inspections and tests include, but are not limited to, fill control (compaction), asphalt density, rebar inspection, and concrete testing, which shall be performed by a commercial testing laboratory of Thornton's choosing and at Thornton's expense. Contractor shall perform excavation Work necessary for compaction testing, as requested by Thornton's testing

agent. Contractor may observe all such QA inspections and tests. Note, Thornton's Quality Assurance tests and inspections do not relieve Contractor of their Quality Control responsibilities.

2. Rejection of Work Resulting from Quality Assurance Inspection, Tests by Thornton. In the event Thornton's QA inspection or test fails to meet the acceptance criteria established by the Specifications, another inspection or test will be performed after the necessary corrective Work has been completed by Contractor. Contractor shall bear the expense of all the re-inspections and/or re-tests required, and such cost shall not be compensated. Thornton shall have the right to back charge Contractor for its QA re-inspections and re-tests and to deduct the cost of re-inspections and re-tests from payments due or that become due to Contractor.

C. Quality Control Tests, Inspections.

1. Notice Required. Contractor shall provide a minimum of two (2) Business Days' notice to Thornton of Contractor's schedule for the required Quality Control ("QC") field inspections or tests to allow Thornton the opportunity to observe such inspections and tests. Failure to give two (2) Business Days' notice to Thornton may require that the QC inspection or tests be delayed. If two (2) Business Days' notice is not provided, Contractor shall not be entitled to an extension of the Contract Time and will not be relieved of required acceptance inspections or tests of any finishing, Materials or Equipment.
2. Inspections and Tests Required. Contractor shall perform QC inspections and tests as specified in the Contract Documents and in accordance with Contractor's QC Program. Contractor shall furnish reports of results to Thornton. The QC inspection agency and testing laboratory proposed by Contractor shall be subject to approval by Thornton, and Contractor shall pay the cost of the QC inspections, tests and any re-tests that may be required, including all transportation charges.

D. Quality Assurance and Quality Control Program, Standards.

1. Inspections and Tests Standards. All QA and QC inspections, tests and re-tests, unless otherwise provided in the Specifications, shall be in accordance with the pertinent sections of the latest edition of the standards applicable to the Material, Equipment or devices to be tested.
2. Covered QA and QC Work Before Thornton Inspection. If any Work is covered up without Thornton being afforded the opportunity to perform its QA inspections or tests or to observe Contractor's QC inspections or tests, Thornton may require it be uncovered for examination by Thornton at Contractor's expense.

E. Thornton's Right to Inspect Covered Work.

1. Notice Required. Contractor shall inform Thornton when Work is scheduled to be covered up to allow Thornton adequate time to review and inspect it.
2. Inspection of Covered Work. Thornton may request to examine a portion of the Work that Contractor has covered to determine if the Work has been performed in accordance with the Contract Documents. The costs of uncovering, and recovering the Work shall be at Contractor's sole expense, shall not be included in the Contract Price, and Contractor shall not be entitled to a change in the Contract Time or the Contract Price.
3. Rejection of Covered Work. Thornton reserves the right to reject and require correction of any Work not completed in accordance with the Contract Documents.
4. Correction of Rejected Covered Work. Contractor shall promptly correct Work rejected by Thornton or failing to conform to the requirements of the Contract Documents, whether discovered before or after Substantial Completion and whether or not fabricated, installed or completed. Costs of correcting rejected Work, including additional testing and inspections, the cost of uncovering and replacement, and compensation for any design consultant employed by Thornton whose expenses and compensation were made necessary as a result, shall be at Contractor's sole expense.

- F. Special Inspection. If after commencement of the Work, Thornton determines that any Work requires special inspection, testing or approval not otherwise provided for in the Contract Documents, Thornton shall issue written authorization instructing Contractor to order such special inspection, or testing and Contractor shall give timely notice of its readiness and of the date arranged so Thornton may observe such special inspection or testing. If such special inspection or testing reveals a failure of the Work to comply with the Contract Documents, or with Laws, ordinances, rules, regulations, or orders of any public authority having jurisdiction over the Work, Contractor shall bear all costs of such special inspection and/or testing.

VII. PRODUCT SUBSTITUTIONS AND "OR EQUAL" CLAUSE

- A. Purpose of Referenced Products. The inclusion of a manufacturer's name, trademark, or other proprietary identification of a specified product shall not limit competition among Subcontractors or Material Suppliers, but shall establish a standard of quality, implying an "or equal" clause, unless expressly specified otherwise as "No Substitutions Allowed."
- B. Reference to Standard Specifications. Any reference to standard specifications in any of the Contract Documents shall always imply the latest edition of such standard specification or specifications available at the time the Agreement was executed.

C. Product Substitution Requirements. The substitution of a product shall be, without limitation, subject to any requirements listed in the Special Conditions or other parts of the Contract Documents and the following conditions:

1. It is determined by Thornton that the proposed substitute product is equal or superior in properties of construction, durability, quality, character, appearance, strength, and design characteristics to that specified;
2. It will reliably perform at least equally as well in function and achieve the results imposed by the design concept of the completed Project as a functioning whole;
3. It has a proven record of performance and availability of responsive service;
4. Such changes as may be required in the Work to install the substitute product and to properly integrate it into the Work are approved by Thornton;
5. The effect of the substitution on the total cost of the Work is approved by Thornton; and
6. Contractor certifies that, if approved and incorporated into the Work:
 - a. All costs for changes due to substitutions are the responsibility of the Contractor, and
 - b. Contractor will provide at least the same warranty for the substitution that Contractor would have provided for the product specified.

D. Request for Product Substitution.

1. If substitutions are allowed, the substitution of a product in place of that specified shall be permitted only upon Thornton's issuance of a Change Order in response to a formal request submitted by Contractor sufficiently in advance to allow adequate time for evaluation by Thornton. If Thornton, in its sole discretion, determines that tests are necessary for a proper evaluation, such testing shall be performed as specified by Thornton and at the expense of Contractor.
2. Requests for changes in products, Materials, Equipment, and methods of construction required by the Contract Documents proposed by Contractor after the Agreement is executed by Thornton are considered requests for "substitutions."

E. Product Substitution Submittal Process.

1. Contractor shall submit electronic or digital copies of each request for substitution to Thornton for consideration. Such requests shall be submitted in the form and in accordance with procedures required for Change Orders. Contractor shall submit required documents with sufficient time so as to not

impact the critical path schedule of the Project, taking into account review times and document control times.

2. Contractor shall identify the product or the fabrication or installation method to be replaced in each request and include related Specification sections and Drawing numbers. Contractor shall provide complete documentation showing compliance with the requirements for substitutions and the following information, as appropriate:
 - a. Product Data, including Drawings and descriptions of products, fabrication, and installation procedures where applicable;
 - b. Samples, where applicable or requested;
 - c. A detailed comparison of significant qualities of the proposed substitution with those of the Work specified. Significant qualities may include elements such as size, weight, durability, performance and visual effect;
 - d. Coordination information, including a list of changes or modifications needed to other parts of the Work and to construction performed by Thornton and Separate Contractors that will become necessary to accommodate the proposed substitution;
 - e. The substitution's effect on the CPM Schedule compared to the CPM Schedule without approval of the substitution. Indicate the effect of the proposed substitution on the Contract Time;
 - f. Cost information, including a proposal of the net change, if any, in the Contract Price; and
 - g. Certification by Contractor that the substitution proposed is equal-to or better in every significant respect to that required by the Contract Documents and that it will perform adequately in the application indicated. Include Contractor's waiver of rights to additional compensation or time that may subsequently become necessary because of the failure of the substitution to perform adequately.
3. Contractor's substitution request will be received and considered by Thornton when the following conditions are satisfied, as determined by Thornton; otherwise requests will be returned without action except to record noncompliance with these requirements:
 - a. Extensive or costly revisions to the Contract Documents are not required;
 - b. Proposed changes are in keeping with the general intent of the Contract Documents;

- c. The request is timely, fully documented and properly submitted;
 - d. The request is directly related to a “similar products” clause or similar language in the Contract Documents;
 - e. The specified product or method of construction cannot be provided in time to meet the Contract Time, or the specified product or method of construction cannot receive necessary approval by a governing authority and the requested substitution can be approved. The request will not be considered if the product or method cannot be provided as a result of Contractor’s failure to pursue the Work promptly or coordinate activities properly; and
 - f. In Thornton’s sole determination, a substantial advantage is offered, in terms of cost, time, energy conservation or other considerations of merit, after deducting offsetting responsibilities Thornton may be required to bear.
4. Evaluation by Thornton. Within seven (7) Days of receipt of the request for substitution, Thornton may request additional information or documentation necessary for evaluation of the request. Within fourteen (14) Days of receipt of the request, or seven (7) Days of receipt of the additional information or documentation, whichever occurs later, Thornton will notify Contractor of acceptance or rejection of the proposed substitution. If a decision on use of a proposed substitution cannot, or has not been made or obtained within the time allocated, Contractor shall use the product originally specified. Acceptance will be in the form of a Change Order.
5. Contractor’s submittal and Thornton’s acceptance of Shop Drawings, Product Data or Samples that relate to construction activities not complying with the Contract Documents does not constitute an acceptable or valid request for substitution, nor does it constitute approval. Any deviations from the Drawings and Specifications shall clearly reference the approved substitution request and shall comply with all submittal requirements in the Contract Documents.
6. The following are not considered substitutions:
- a. Thornton Revisions to the Contract Documents requested by Thornton;
 - b. Specified options of products and construction methods included in the Contract Documents; and
 - c. Contractor’s determination of and compliance with governing regulations and orders issued by authorities having jurisdiction over the Work.

VIII. WARRANTY PERIOD

- A. If, prior to Final Acceptance or within one (1) year after the date of Initial Acceptance, or for such longer periods of time as may be set forth with respect to specific warranties required by the Contract Documents or certain Equipment noted in the Specifications, any Defective Work is found, Thornton shall promptly notify Contractor in writing. Unless Thornton provides written acceptance of the Defective Work, Contractor shall promptly correct the Defective Work at its own cost and time and bear the expense of any services required for correction of any Defective Work.

With respect to any portion of Work corrected after Initial Acceptance, the Warranty Correction Period shall be extended for this portion of Work by the period of time elapsed between Initial Acceptance and the completion of the corrected Work.

If Contractor fails to commence correction of Defective Work within thirty (30) Days after receipt of written notice from Thornton, Thornton may correct the Defective Work in accordance with Thornton's right to carry out the Work. In such case, Thornton shall send an invoice to Contractor for the cost of correcting the Defective Work and Contractor shall promptly pay Thornton.

- B. Other Contract Obligations Not Tolerated by Warranty Period. The Warranty Correction Period for Defective Work does not constitute a limitation period with respect to Thornton's right to enforce Contractor's other obligations under this Agreement or the Contract Documents.

- C. After Warranty Period.

1. Contractor's obligations and liability with respect to any Defective Work discovered after the Warranty Correction Period shall be determined by applicable Laws.
2. If after the Warranty Correction Period, but before the applicable limitation period has expired, Thornton discovers any Defective Work, Thornton shall, unless the Defective Work requires emergency correction, promptly notify Contractor and allow Contractor an opportunity to correct the Defective Work at its cost. If Contractor elects to correct the Defective Work, it shall provide written notice of such intent within seven (7) Days of its receipt of notice from Thornton and shall complete the correction of Defective Work within the mutually agreed upon time. If Contractor does not correct the Defective Work, Thornton may have the Defective Work corrected, and shall promptly provide Contractor with an accounting of the correction costs, which shall be paid by Contractor to Thornton upon demand.

- D. Damage Caused by Defective Work. If Contractor's correction or removal of Defective Work causes damage to or destroys other completed or partially completed Work or other property, Contractor shall be solely responsible for promptly correcting the damage and for the cost of correcting the destroyed or damaged property.

- E. Acceptance of Defective Work. Prior to Initial Acceptance, at Thornton's option and with Contractor's concurrence, Thornton may elect to accept Defective Work rather than require its removal or correction. In such case, the Contract Price shall be adjusted for any diminution in the value of the Project resulting from such Defective Work. Alternately, Thornton, at its sole discretion, may elect to accept alternate warranty terms it deems to be in Thornton's best interest.

IX. MINOR CHANGES, CLAIMS FOR CHANGES IN THE WORK, & CONTRACT PRICE

- A. Change in the Work by Thornton. Without invalidating the Contract and without notice to any surety, Thornton reserves the right, at any time or from time to time during the progress of the Work, to make necessary alterations to, deviations from, additions to, or deletions from the Work, or require the performance of additional Work ("Changed or Extra Work") by a Change Order not covered by the Drawings and Specifications nor included in the Contractor's Bid Proposal, but forming a part of the contracted Work ("Change Order"). Upon receipt of a Change Order, Contractor shall promptly proceed with the Work involved which will be performed under the applicable conditions of the Contract Documents (except as otherwise specifically provided).
- B. Notice Required. For any claim for an increase in the Contract Price and/or Contract Time, Contractor shall give Thornton written notice of the claim within ten (10) Days after the occurrence giving rise to the claim. Failure to strictly comply with the time requirements herein shall be deemed a waiver of the claim for Contract Price increase or extension of Contract Time by Contractor.
- C. Unilateral Change Order (UCO).
1. Thornton may issue a written UCO directing a change in the Work prior to reaching agreement with Contractor on the adjustment, if any, in the Contract price and/or the Contract Time.
 2. Thornton and Contractor shall negotiate for appropriate adjustments, as applicable, to the Contract Price or the Contract Time arising out of a UCO. As the changed Work is performed, Contractor shall submit its costs for such Work with its Application for Payment beginning with the next Application for Payment within thirty (30) Days of the issuance of the UCO. The Parties reserve their rights to dispute the UCO amount or Contract Time, subject to the General Conditions' Article XXVI.
- D. Minor Change
1. Minor changes in the Work are changes that do not involve an adjustment in the Contract Price and/or the Contract Time and do not materially and adversely affect the Work, including the design, quality, performance, and workmanship required by the Contract Documents. Thornton shall have the authority to order minor changes that do not involve extra cost or Contract Time and are not inconsistent with the design concept and purposes of the Work.

2. In giving verbal instructions, Thornton shall have the authority to make minor changes that do not involve extra cost or Contract Time and are not inconsistent with the design concept and purposes of the Work; but otherwise, except in an emergency endangering life or property, no Changed or Extra Work shall be performed unless pursuant to a Change Order approved by Thornton, and no Claim for Extra Cost shall be valid unless so approved, except as otherwise provided herein.
3. In the event Contractor determines a minor change in the Work is desired, Contractor shall promptly inform Thornton, in writing, of any such minor changes proposed to be made by the Contractor. Provided Thornton approves in writing that such change is minor, the Contractor may make minor changes in the Work consistent with the intent of the Contract Documents. The Contractor shall record all such changes on the Record Drawings maintained by the Contractor.

E. Change Order Required.

1. The Contractor shall not proceed with any Changed or Extra Work without a written Change Order approved in writing by Thornton. Any Changed or Extra Work performed by Contractor without written approval from Thornton shall be done solely at the Contractor's risk, and the Contractor waives any claim for additional compensation and/or extension of Contract Time.
2. Changed or Extra Work shall in no way invalidate the Contract or the Contractor's Bonds, any difference in cost shall be added to or deducted from the Contract Price. No anticipated profits shall be allowed on Work that is deleted.
3. Final Resolution of Changes – Contractor. Upon execution of a Change Order and/or a UCO by Thornton, all costs and time issues claimed by Contractor regarding that change are final and not subject to adjustment or increase.

F. Contract Price Change. Adjustments, if any, in the Contract Price by reason of any such Changed or Extra Work shall be determined by one of the following methods in the order as listed, or, if appropriate, as solely determined by Thornton, or it may be a combination of the methods listed below.

G. Method A. By applicable Unit Prices contained in the Contractor's Bid Proposal for the same or similar type or class of Work as determined by Thornton.

H. Method B. If applicable, Unit Prices were not included in the Contractor's Bid Proposal, then by a Unit Price proposal for the Changed or Extra Work from the Contractor that is accepted by Thornton.

I. Method C. If applicable, Unit Prices were not included in the Contractor's Bid Proposal and a Unit Price proposal is not practical or cannot be mutually agreed

upon, then by a lump sum price proposal for the Changed or Extra Work from the Contractor that is accepted by Thornton.

- J. Method D. If applicable, Unit Prices were not included in the Contractor's Bid Proposal, and if Thornton and the Contractor cannot mutually agree on pricing per Method B or C before Thornton requests the Contractor to begin Work on the Changed or Extra Work, then the Contractor shall be paid the "actual field cost", as defined below.

Each Party must notify the other Party in advance of utilizing Method D to allow each Party the opportunity to perform its due diligence during the performance of the Changed or Extra Work. Failure of the Contractor to notify Thornton in advance that it disagrees with the application of Methods A, B, or C shall bar the Contractor from unilaterally using Method D.

- K. Method A. Method A is applicable to price Changed or Extra Work when the following conditions are met:

1. When the same or similar type or class of work, as determined by Thornton, is contained in the Contractor's Bid Proposal as a Pay Item;
2. When Unit Prices are provided in the Bid Proposal for the Pay Item;
3. When the actual final quantity, after adding in the Changed or Extra Work, is not less than seventy-five percent (75%) nor greater than one hundred twenty-five percent (125%) of the total estimated quantity for the applicable Pay Item;
4. If condition (1) and (2) are met, but the actual final quantity is less than seventy-five percent (75%) or greater than one hundred twenty-five percent (125%) of the total estimated quantity for the applicable Pay Item, and if a larger quantity variation was expected as expressly noted on the Bid Proposal Form, then Method A shall be used to price the Changed or Extra Work regardless of the final actual quantity installed; and
5. If condition (1) and (2) are met, but the actual final quantity is less than seventy five percent (75%) or greater than one hundred twenty-five percent (125%) of the total estimated quantity for the applicable Pay Item, and if a larger quantity variation was not expected as expressly noted on the Bid Proposal form, then Method B or C shall be used to price the Changed or Extra Work; provided however, that the original estimated quantity shall be paid at the original Unit Price proposed for the particular Pay Item.

- L. Methods B and C. Under Methods B and C, Contractor shall provide backup documentation showing an estimated itemized cost breakdown for labor (including labor man-hours), Materials and Equipment installed in the Work, Construction Equipment (including rental equipment) utilized in the performance of the Work, Subcontractor costs, incidental expenses, and overhead and profit not to exceed

fifteen percent (15%) of the total Change Order price. Documentation shall be sufficient to enable Thornton to evaluate Contractor's Unit Price or lump sum proposal.

M. Method D. When any Changed or Extra Work is performed under Method D, the term "actual field cost" is defined to be and shall include:

1. The actual payroll cost, including payroll taxes of all workers such as foremen, equipment operators, carpenters, electricians, mechanics, and laborers for the time actually engaged in performing the Changed or Extra Work. No other labor related costs will be allowed including, but not limited to, Contractor's management or supervisory personnel, home office personnel, employee benefits, employee bonuses, insurance, and any other incidental costs. An allowance for these indirect costs is covered in the Contractor's allowable markup on the actual field cost, as described below;
2. The actual cost of all Materials and Equipment incorporated into the Changed or Extra Work;
3. The cost of all Construction Equipment for the time actually employed or used in the performance of the Changed or Extra Work based on the Colorado State Department of Transportation's Equipment Schedule or other industry standard publication acceptable to Thornton and in force on the date of the Change Order request;
4. Transportation charges at cost necessarily incurred in connection with any Construction Equipment authorized by Thornton for use on such Changed or Extra Work, but which is not already on the Project site;
5. The actual cost of all power, fuel, lubricants, water, and similar operating expenses as well as other expendable materials such as small tools;
6. All incidental expenses incurred as a direct result of such Changed or Extra Work, including a prorata portion of premiums related to the Contractor's Bonds, and where the premiums therefore are based on payroll costs, on insurance required by the Contract;
7. In determining the amount payable to the Contractor for a Subcontractor's Work, the Contractor must either obtain a minimum of three (3) competitive firm fixed quotes for the subcontracted Work, or if using an existing Subcontractor, shall require the Subcontractor to submit documentation as required herein to determine the Subcontractor's actual field cost. If the Subcontractor's actual field cost is used to determine the Contractor's overall reimbursement for the Changed or Extra Work, the Subcontractor's markup on its cost of Work to cover its general management and supervisory personnel, home office personnel, employee benefits, employee bonuses, insurance, taxes other than payroll taxes, any other incidental costs,

overhead and profit, and all other elements of cost not embraced within the actual field cost as defined herein, shall not exceed fifteen percent (15%) of its actual field cost;

8. The Contractor's markup on self-performed work may not exceed fifteen percent (15%) of the actual field cost for such work. This markup shall cover and be full compensation for the Contractor's general management and supervisory personnel, home office personnel, employee benefits, employee bonuses, insurance, taxes other than payroll taxes, any other incidental costs, overhead and profit, and all other elements of cost not embraced within the actual field cost as defined herein. The Contractor's markup on subcontracted Work shall not exceed five percent (5%) of the Subcontractor's cost whether determined by a competitive quote or by the Subcontractor's actual field cost plus its markup as defined herein, whichever is applicable. No "pyramiding" or additional percentage shall be authorized for the Contractor for any Changed or Extra Work performed by Subcontractors.
9. When any Changed or Extra Work is performed under Method D, Thornton shall direct the form in which the accounts of the actual field costs shall be kept by Contractor. Contractor must specify in writing the proposed method of doing the Work and the type and kind of Construction Equipment, if required, that will be used in the performance of the Changed or Extra Work. Thornton must agree in writing to the methodology before Contractor may commence the Changed or Extra Work. Contractor shall furnish satisfactory bills, payrolls and vouchers covering all items of cost when requested by Thornton and give Thornton access to the related accounts.
10. Should Thornton and the Contractor be unable to agree on the method for pricing Changed or Extra Work or on the total value of the Changed or Extra Work, Thornton may utilize any combination of Methods A, B, C, and D to develop a Change Order to facilitate the continuation of the Work and payment without delay.
11. Any Changed or Extra Work shall be considered a part of the Contract, subject to all of its terms, conditions, stipulations, review, warranties, and tests and may be performed without notice to the Surety. Contractor and its Surety hereby agree to these provisions.
12. It is Contractor's and Surety's joint responsibility to be aware of all Contract Change Orders and to ensure that the Contract value under the Labor and Material Payment and Performance Bonds are modified as appropriate with each Change Order. In addition, the Surety shall ensure that Contractor's bonding limit has not been exceeded by any Contract Change Order.

N. Claims for Extra Cost by Contractor.

1. If it appears to Contractor that Changed or Extra Work is required, and in their opinion, they should receive additional compensation, then within ten (10) Calendar Days of Contractor knowing or should have known of the condition giving rise to the Changed or Extra Work requiring additional compensation, Contractor shall give written notice for a Claim of Extra Cost to Thornton's Contract Administration Division. Thornton must authorize Contractor's request for a Change Order for Changed or Extra Work. Contractor shall simultaneously provide a copy of said claim to Thornton's Field Representative. Should a difference of opinion arise as to what does or does not constitute Changed or Extra Work, or being paid for the extra incurred cost, and Thornton insists on immediate conformance, Contractor shall proceed with the Work after presenting its written notice to Thornton. Performance by Contractor of the Work in question shall not prejudice Contractor's ability to receive additional compensation for a Claim for Extra Cost. However, failure to submit timely notice to Thornton in accordance with this section constitutes a complete waiver by Contractor of its claim for extra cost for Changed or Extra Work.
2. Provided timely notice has been filed with Thornton, and provided Method A for pricing Changed or Extra Work does not apply and provided that Thornton and the Contractor have not agreed upon pricing per Methods B and C, Contractor shall keep an accurate account of the "actual field cost", as provided for in Method D in Article IX of these General Conditions. Contractor shall not waive any right it might have to compensation for a Claim for Extra Cost in connection with the Changed or Extra Work. Upon receipt of the Contractor's Claim for Extra Cost, Thornton will make a final determination as to whether or not Changed or Extra Work was involved and, if so, the amount due to the Contractor.
3. Contractor shall provide to Thornton all supporting documents and receipts in support of its Claim for Extra Cost within thirty (30) Calendar Days after performing the Work for which extra cost is claimed. Thornton shall have the right to reject any Claim for Extra Cost if the foregoing procedure is not followed. Failure to submit accurate and complete supporting documentation within thirty (30) Calendar Days after performing the Work shall constitute a complete waiver of the claim by the Contractor.

X. CONTRACT TIME

- A. Contract Time. Adjustments, if any, in the Contract Time by reason of any Changed or Extra Work shall be determined in accordance with this Article X, Contract Time.

- B. The Contractor expressly agrees that in undertaking to complete the Work within the Contract Time, it has taken into consideration and made allowances in the Schedule of Work for all delays and hindrances incidental to such Work, whether growing out of delays in securing Materials and Equipment, labor, normal inclement weather, or otherwise.
- C. If the Contractor is delayed at any time in the progress of the Work by an act or omission of Thornton, any separate contractor employed by Thornton, Changed or Extra Work, industry-wide labor strikes, fire, epidemics, quarantine restrictions, freight embargoes, unavoidable casualties, abnormal weather conditions (further described in this Article below), causes beyond the Contractor's control, or by any other cause which Thornton determines may justify the delay, the Contract Time shall be extended for such reasonable time as Thornton may determine based on the timing and submittal requirements set forth below; provided, however, that such delay could not have been avoided by the exercise of due diligence by the Contractor.
- D. No extension of the Contract Time will be granted for:
1. When there are variations between the original estimated Contract Pay Item quantity, and the actual Pay Item quantity, unless such variance is one hundred twenty-five percent (125%) or more than the original estimated Contract Pay Item quantity, and the unit priced bid item did not indicate that the Contractor should expect changes in this unit priced bid item (usually noted with an asterisk (*));
 2. Rain, snow, wind, flood, or natural phenomena of normal intensity for the locality where the Work is to be performed;
 3. Acts or omissions of Contractor or its Subcontractors caused the delay;
 4. Delays occurring concurrently (either at the same time, on the same critical path, or on a concurrent critical path) with delays attributable to acts or omissions of the Contractor or its Subcontractors; and
 5. A delay occurring to an activity which is not on the then-current critical path.
- E. Written Notice for an Extension Required. A request for an extension of the Contract Time shall be submitted in writing to Thornton no later than ten (10) Calendar Days after the delay commences. In the case of a continuing delay for the same cause, only one request is necessary. The Contractor shall support its request for an extension of the Contract Time with a supplemental submittal, which shall be submitted to Thornton within fourteen (14) Calendar Days of submitting the initial request. The Contractor's supplemental submittal shall include:
1. A description of the activities that were delayed, the reasons for the delay, an explanation of how they were delayed, and a detailed factual statement relative to all relevant dates, locations, etc.;

2. A schedule analysis (based on the critical path method) which shows in graphic form how and where a delay on the then-current critical path occurred and its effect on any Milestone Date or the Substantial Completion Date; and
 3. An explanation of the Contractor's efforts to reschedule the Work in order to mitigate the effect of the delay and/or prevent further delays.
- F. In the event Contractor requires more than fourteen (14) Calendar Days to provide the supplemental submittal, the Contractor shall request in writing an extension of time from Thornton within the fourteen (14) Calendar Day period. If the supplemental submittal, or a request for an extension of time to submit the supplemental submittal is not received by Thornton within the fourteen (14) Calendar Day period, the Contractor waives any claim for an extension of Contract Time therefor.
- G. If abnormal weather conditions are the basis for a request for an extension of the Contract Time, such request shall be supported by data substantiating that weather conditions during the period of time impacted were unusually severe and could not have been reasonably anticipated. To establish the existence of abnormal weather, the Contractor must submit documentation which shows that the weather conditions experienced in a given calendar month fall outside of the extreme ranges of weather data for the Denver area published by the National Climatic Data Center during the same calendar month over the prior ten (10) year period. The existence of abnormal weather is not sufficient in itself to justify an extension of Contract Time; the Contractor must still demonstrate that the abnormal weather delayed specific activities that were on the then-current critical path that controlled the overall completion of the Work.
- H. Failure to strictly comply with the timing and submittal requirements of this section shall constitute a waiver by Contractor of any request for an extension of the Contract Time. All extensions to the Contract Time shall be by Change Order. No oral extensions of Contract Time shall be granted by Thornton or may be relied upon by the Contractor.
- I. Notwithstanding anything to the contrary in the Contract Documents, an extension to the Contract Time, to the extent permitted under this section, shall be the sole and exclusive remedy of the Contractor for any delay in the commencement, prosecution, or completion of the Work; hindrance, interference, or obstruction in the Contractor's performance of the Work; loss of productivity; or other similar claims, whether or not such delays are foreseeable. In no event shall the Contractor or its Subcontractors be entitled to any compensation or recovery of any damages in connection with any delay to the Work. The Contractor hereby waives any and all claims past, present, or future for monetary damages arising out of or related to any delay or interference including, without limitation, consequential damages, lost opportunity costs, lost profits, impact damages, acceleration damages, loss of labor productivity damages, all other time related damages, or other similar remuneration against Thornton. Thornton's exercise of

any of its rights or remedies under the Contract Documents, regardless of the extent or frequency of Thornton's exercise of such rights of remedies, shall not be construed as active interference with the Contractor's performance of the Work.

XI. DIFFERING SITE CONDITIONS

A. Differing Site Conditions are:

1. Actual subsurface or latent physical conditions at the Project Site that differ materially from those indicated in the geotechnical baseline; or
2. Unknown physical conditions at the Project Site, of an unusual nature, which differ materially from those ordinarily encountered and generally recognized as inherent in Work.

B. Differing Site Conditions exclusions are:

1. Conditions of which Contractor had actual or constructive knowledge as of the date of the Agreement; and
2. Conditions that should have been discovered through a reasonable investigation.

C. Discovery of Differing Site Condition. Upon discovering an alleged Differing Site Condition and after taking appropriate measures to secure the Work and before the condition is further disturbed, Contractor shall:

1. Stop work in and secure the affected area; and
2. Notify Thornton of the alleged Differing Site Condition. Contractor's notice to Thornton shall be issued by telephone or in person and followed within twenty-four (24) hours by a written notice providing a brief description and supporting documentation of why Contractor considers the condition encountered to be a Differing Site Condition. Upon receipt of Contractor's notice, Thornton will investigate the Differing Site Conditions. No increase in the Contract Price or Contract Time shall be allowed for any alleged Differing Site Condition unless Contractor has given notice as required herein.

D. Thornton's Review. After receipt of Contractor's written notice as required by Article XI, Section C, if Thornton investigates and concludes that:

1. Such condition(s) differ materially and cause an increase or decrease in the Contractor's cost of, or time required for, performance of any part of the Work, Thornton will equitably adjust the Contract Price or Contract Time or both.

2. The condition(s) at the site are not materially different from those indicated in the Contract Documents, and that no change in the terms of Contract is justified, Thornton will provide written notice to Contractor stating the reasons denying Contractor's request for an adjustment of the Contract Price or Contract Time or both.
3. Contractor may request an appropriate Change Order if the actual condition encountered directly and materially impacts Contractor's cost or time of performance of the Work.

XII. PARTIAL USE; RIGHT OF OCCUPANCY.

- A. If Thornton finds it necessary to occupy or use a portion or portions of the Work prior to Substantial Completion, Thornton shall have the right to use or occupy any completed or partially completed portions of the Work. Thornton shall notify Contractor in writing of its intent to occupy any completed or partially completed portion of the Work. Thornton's partial use or occupancy is not an acceptance of any Work until Contractor has completed all Work in accordance with the Contract Documents nor does it release Contractor of its obligation with respect to any expressed or implied warranties or constitute acceptance of Work that is defective, partially completed or not in compliance with the Contract Documents.
- B. If Thornton's partial use or occupancy increases Contractor's cost, or delays completion of the Work, Contractor may request in writing to Thornton, to adjust the Contract Price, Contract Time, or both.
- C. If Thornton does occupy or use a portion or portions of the Work prior to substantial completion, the insurers providing the property insurance shall consent by endorsement to the policy or policies, and shall not cancel or let the property insurance lapse on account of any such partial use or occupancy.
- D. If Thornton determines designated elements of the Project are required for partial use or occupancy before Substantial Completion, the parties agree that as the Work is completed, prepared and made ready for use, the provisions of the Contract related to inspections, occupancy, and acceptance will apply independently to each part of the Work Thornton intends to use. For all other purposes, unless otherwise agreed by the parties in writing, Substantial Completion of the Work as a whole is the date on which all the completed Work receives a Substantial Completion certificate.
- E. Such occupancy or use of portions of the Work may commence whether or not portion is substantially complete. Issuance of Substantial Completion for a portion of the Work will be solely for Thornton's convenience. Thornton shall not be obligated to issue Substantial Completion on any portion of the Project until the entirety of the Work is substantially complete.

XIII. SUBSTANTIAL COMPLETION

- A. When Contractor considers the Work to be substantially complete, Contractor shall make a written request to Thornton for the issuance of a letter of Substantial Completion. Thornton, upon receipt of the request, shall make an inspection of the Work and either issue a written letter of Substantial Completion together with a Punch List, or deny Contractor's request in writing and provide the reasons for such denial. Issuance of a letter of Substantial Completion will stop the accrual of Liquidated Damages.
- B. In the case where Contractor has requested that Thornton issue a letter of Substantial Completion but Thornton has denied such request, Contractor shall complete the Work so as to address Thornton's concerns and comply with the Contract Documents and shall again request in writing that Thornton issue a letter of Substantial Completion. Thornton will administer any subsequent requests as outlined in this Section.
- C. If Thornton issues a letter of Substantial Completion, the letter shall list any items remaining to be completed as Punch List Work and shall set a date certain by which Contractor shall complete or correct the Punch List Work.
- D. If Contractor does not provide in writing within four (4) Days of the issuance of the letter of Substantial Completion, good and sufficient reasons why the Punch List Work cannot be completed by the date established in the letter of Substantial Completion, the date shall be as established in the letter, and the Punch List Work shall be completed by that date.
- E. If Contractor does not complete the items on the Punch List by the date established in the letter of Substantial Completion, Thornton, upon seven (7) Days' notice to Contractor, shall have the option to withhold from Final Payment up to two (2) times the estimated value of the uncompleted Punch List Work, to complete any uncompleted Work or repair deficient Work with its own forces, to deduct the actual cost from any amounts due or that become due to Contractor, and/or to seek compensation from the Surety.
- F. Upon completion of the Punch List Work, Contractor shall make written application to Thornton for an inspection of the Work, and Thornton will make such inspection. When Thornton finds the Work acceptable and complete under the Contract Documents, Thornton will advertise at least twice ten (10) Days before the Project's published Final Settlement date, to allow any person, as defined in § 2-4-401(8), C.R.S., that has furnished labor, materials, or other supplies used or consumed by Contractor or Contractor's subcontractors to file a verified statement of any amount due and unpaid. Thereafter, Thornton will withhold the amounts of the disputed claims for up to ninety (90) Days from the published Final Settlement date. At the expiration of the Ninety (90)-Day period, Thornton will pay the withheld funds to Contractor and will grant Initial Acceptance unless an action is commenced or pending to enforce the unpaid claims, and a valid notice of *lis pendens* has been filed with Thornton. Initial Acceptance shall not release

Contractor from any warranty obligations. The Warranty Correction Period shall begin on the Date of Initial Acceptance. Thornton shall issue Initial Acceptance in writing, which shall set out the beginning and end dates for the Warranty Correction Period.

XIV. PAYMENTS

- A. No progress or Final Payment, nor any partial or entire use or occupancy of the Work, nor acceptance thereof, by Thornton shall be construed to be acceptance of Defective Work or improper Materials or Equipment, either wholly or in part. The Contractor's obligation to perform and complete the Work in strict accordance with the Contract Documents shall be absolute.
- B. Upon request by Thornton, and if required, the Pay Item Price for mobilization shall include any "startup" or incidental costs necessary to begin the Work, including any necessary Construction Equipment, offices, buildings, Materials or Equipment, personnel that are to be located at the Project Site in preparation for the Work, bonds, insurance, permits, and any other incidental expenses that cannot otherwise be attributed directly to the other Schedule of Values items.
- C. Mobilization. Payments for mobilization shall be made monthly in accordance with the following table.

Percentage of Contract Amount Complete	Percentage of Mobilization Paid
5%	25%
10%	50%
25%	60%
50%	100%

The overall Pay Item price for mobilization shall not exceed ten percent (10%) of the original Contract Price. If Contractor submits a bid where the mobilization exceeds ten percent (10%) of the original Contract Price, Thornton may declare the bid unbalanced and front loaded and reject the bid.

- D. Applications for Payment.
 - 1. Applications for Payment shall be on forms provided by Thornton or on Contractor's standard forms with prior written approval of Thornton. Applications for Payment shall be supported by complete detailed back-up documentation and such data as Thornton may require which shall be used as a basis for reviewing Contractor's Applications for Payment and substantiating Contractor's right to payment.

2. With each Application for Payment, Contractor shall submit an updated CPM Schedule.
3. By submitting an Application for Payment, Contractor certifies that to the best of Contractor's knowledge, information, and belief, the Work covered by the Application for Payment has been completed in accordance with the Contract Documents, and that all amounts have been paid by Contractor to its Subcontractors, Material Suppliers and Equipment Suppliers for Work for which previous Applications for Payment were certified and issued, and for which payments were received from Thornton, and that the current amount shown in the Application for Payment is properly due.

E. Progress Payments.

1. No later than the twenty-fifth (25th) Day of each month after the Work has commenced or on the date otherwise established by Thornton, Contractor shall submit to Thornton an itemized Application for Payment for Work completed to date for this pay period.
2. Payments are due and payable within thirty (30) Days after the date of acceptance and approval by Thornton of an Application for Payment. On or before the thirtieth (30th) Day following acceptance and approval, Thornton shall pay Contractor the undisputed amount for which Application for Payment is made, less amounts previously paid by Thornton, and less retainage withheld pursuant to requirements herein, and less other amounts allowable to be withheld as by Thornton as set forth in the Contract.
3. Contract with Unit Price: Contractor may reasonably expect variations in the estimated quantity for any given Pay Item such that the actual quantity installed may range from seventy-five percent (75%) to one hundred twenty-five percent (125%) of the estimated quantity unless a larger variation is stipulated on the Bid Proposal form. Contractor shall not be allowed to make a claim for:
 - a. Anticipated profits, lost profits or any damages because of a difference between the estimated quantity for a Pay Item and the actual quantity for the Pay Item; or
 - b. The elimination and/or reduction of a Pay Item quantity required to bring the cost of the Work within the limits of available funds or to reduce the Scope of Work for any reason.

F. Adjustment, Rejection of Payment.

1. Thornton may adjust or reject an Application for Payment or nullify a previously approved Application for Payment, in whole or in part, as may be necessary to protect Thornton from loss or damage based upon the following:

- a. Contractor's failure to perform the Work as required by the Contract Documents;
 - b. Loss or damage arising out of or relating to the Work or this Agreement and caused by Contractor or others for whom Contractor is responsible, except as accepted by the insurer providing Builders Risk, Installation Floater or other property insurance covering the Project;
 - c. Contractor's failure to properly pay Subcontractors, or Material or Equipment Suppliers for labor, Materials, Equipment or supplies furnished in connection with the Work, provided that Thornton is making payments to Contractor in accordance with the terms of this Agreement;
 - d. Defective Work not corrected in a timely fashion;
 - e. Reasonable evidence of delay in performance of the Work such that the Work will not be completed within the Contract Time or that the unpaid balance of the Contract Price is not sufficient to offset any damages that may be sustained by Thornton as a result of delays caused by Contractor;
 - f. Reasonable evidence demonstrating that the unpaid balance of the Contract Price is insufficient to complete the Work; or
 - g. Uninsured third-party claims involving Contractor or reasonable evidence demonstrating that third-party claims are likely to be filed, unless and until Contractor furnishes Thornton with adequate security in the form of a surety bond, letter of credit or other collateral or commitment sufficient to discharge such claims.
2. If an Application for Payment is rejected, in whole or in part, Thornton shall submit to Contractor in writing the reasons for its rejection. Contractor shall revise the Application for Payment and resubmit to Thornton. If Contractor does not agree with Thornton's reasons for rejection, Contractor shall inform Thornton in writing within five (5) Days after receipt of the reasons for rejection from Thornton. If Thornton and Contractor cannot agree on a revised Application for Payment within fifteen (15) Days after Thornton's initial rejection of an Application for Payment, Thornton shall pay Contractor the amount payable for those items not rejected by Thornton, less amounts previously paid by Thornton, and less applicable retainage. Those items rejected by Thornton shall be due and payable when the reasons for the rejection have been cured.

G. Contractor Warranties.

1. Title of Materials and Equipment. Contractor warrants that title to all Materials and Equipment covered by an Application for Payment, whether incorporated into the Work or not, shall pass to Thornton upon receipt of payment, in whole or in part, by Contractor.
2. The passing of title to Thornton shall not be construed as relieving Contractor of its sole responsibility for:
 - a. The care and protection of the Work, Materials and Equipment for which payment has been made;
 - b. The restoration of any damaged or destroyed Work, Materials or Equipment; and
 - c. Such responsibility shall continue until all Work under this Agreement has been completed and accepted by Thornton.
3. Free and Clear of Encumbrances. Contractor further warrants that upon submittal of an Application for Payment for Work for which payment has been received from Thornton, to the best of Contractor's knowledge, information, and belief, such Work shall be free and clear of all liens, claims, security interests, or encumbrances in favor of Contractor, Subcontractors, Sub-subcontractors, Material or Equipment Suppliers, or other persons or entities making a claim by reason of having provided labor, Materials or Equipment relating to the Project; and that such Materials or Equipment furnished or installed comply with the requirements of the Contract Documents.

H. Retainage\Withholding of Funds.

1. Prior to substantial completion, progress payments will be made in an amount equal to the percentage indicated below, less the aggregate of payments previously made, and less other amounts as Thornton is entitled to withhold for the reasons set forth below:
 - a. Performance. Ninety-five percent (95%) of the Work completed (with the balance being retainage). Thornton may determine that as long as the character and progress of the Work remain satisfactory then no additional retainage will be withheld;
 - b. Materials and Equipment. Ninety-five percent (95%) (with the balance being retainage) of Materials and Equipment not incorporated in the Work, but delivered, suitably stored and accompanied by documentation satisfactory to Thornton;

- c. Defective Work not remedied. Thornton may withhold up to two (2) times the estimated value of any Defective Work;
 - d. Non-Compliance. Failure or refusal of Contractor to comply with an instruction of Thornton within a reasonable time;
 - e. Liquidated Damages. Liquidated Damages, if any, assessed against Contractor;
 - f. Arrearages. Being in arrears for any amounts owed to Thornton;
 - g. Failure to supply or update the CPM Schedules; and
 - h. Verified Statement of Claims. Upon receipt of Verified Claim Thornton will hold funds in the amount sufficient to cover the claim(s).
- I. Thornton's progress payment, occupancy or use of the Project, whether in whole or in part, shall not be deemed acceptance of any Work not conforming to the requirements of the Contract Documents and shall not constitute a waiver of Thornton's right to require Contractor to fulfill all of the requirements of the Contract Documents.
- J. Thornton shall make the final determination of the amount, quality, acceptability, and fitness of the Work, including Materials and Equipment, which are to be paid for under this Agreement and shall decide all questions which may arise in relation to such Work.
- K. Payment for Stored Materials.
- 1. If payments are to be authorized on account of Materials and Equipment not incorporated in the Work, but delivered and suitably stored at the Project Site or at an off-site storage warehouse, which are necessary for the orderly performance of the Work, and adequately protected from vandalism or theft, Contractor shall furnish with its Application for Payment bills of sale, bills of lading, certified invoices, paid receipts or such other evidence as may be appropriate and satisfactory to Thornton that establish:
 - a. Actual cost, including transportation to the Project Site, of such Materials and Equipment has been paid in full;
 - b. Titles in Thornton's name upon payment;
 - c. Appropriate insurance coverage to protect Thornton's interest upon payment; and
 - d. Receipt showing materials have been paid in full.

L. Final Payment

1. Contractor shall submit a final Application for Payment upon completion of the Punch List Work. Prior to receiving Final Payment, Contractor, if requested by Thornton, shall file with Thornton:
 - a. Receipts showing payment in full;
 - b. A waiver or release of claims and/or liens from each Subcontractor and supplier for all labor, Materials and Equipment used or furnished by each on the Work; and
 - c. A complete release of all claims from the Contractor which may have arisen under the Agreement;
2. In lieu of the above, Thornton may request, and Contractor shall file statements showing the balance due on all accounts. The manner in which settlement is made by Thornton with Contractor shall not release Contractor or its Surety from their payment obligations.
3. Final Payment shall not be due until Initial Acceptance is granted by Thornton and Final Payment shall not be made until the Date of Final Settlement.
 - a. At the time Thornton makes Final Payment to Contractor, Contractor understands that completion of the following outstanding Claims and work may still be required:
 - i. Outstanding Verified Claims;
 - ii. Work not in conformance with the Contract Documents;
 - iii. Terms of any special warranties required by the Contract Documents;
 - iv. Outstanding claims by Thornton or third parties for damages attributed to Contractor or any person or entity for which it is responsible; and
 - v. Work to be completed under the Warranty Period.

M. Contractor's Release of Claims upon Final Payment

1. The acceptance of Final Payment by Contractor shall operate as a release of all claims by Contractor for all things done or furnished in connection with this Agreement and for every act or omission or neglect of Thornton or others relating to, or arising out of this Agreement, except for claims previously made in writing by Contractor and rejected or remains unsettled by Thornton at the time of Final Payment.

2. No payment, final or otherwise, shall operate to release Contractor, its Surety or its insurers from any obligations under this Agreement or under the Performance Bond or Labor and Material Payment Bond including, but not necessarily limited to, any one or more of the following:
 - a. Obligations arising from or relating to latent defects;
 - b. Faulty Work or Material or Equipment appearing after any payment;
 - c. Failure of the Work to perform in accordance with the requirements of the Contract Documents;
 - d. Unsettled claims of Thornton;
 - e. Claims for non-payment of laborers, mechanics, materialmen or suppliers, or for Equipment used or rented; or
 - f. Claims under any maintenance requirements of the Contract Documents or any special guarantees or warranties provided for under the Contract Documents.
3. When the above grounds are removed, payment shall be made for amounts withheld. The right to withhold payment, however, shall not preclude Thornton from its right to declare this Agreement in default for any of the reasons specified in the Contract Documents.
4. The final amount due to Contractor, as may be adjusted for any outstanding claims or Verified Claims properly filed with Thornton, upon Contractor achieving Initial Acceptance of the Work is payable the following day of Final Settlement. All claims shall be settled before issuance of Final Payment or Thornton may withhold from Final Payment monies sufficient to cover those claims.

XV. INITIAL ACCEPTANCE

- A. When the Contractor believes all Punch List items have been completed to Thornton's satisfaction, the Contractor shall submit a written request for Initial Acceptance. Thornton may then issue Initial Acceptance if it concurs.
- B. Upon issuance of Initial Acceptance, Thornton shall, as required by C.R.S. § 38-26-107, as may be amended, establish the Date of Final Settlement and post or advertise the Notice of Final Settlement. The Work shall be deemed completed satisfactorily and finally accepted by Thornton as those terms are used in C.R.S. § 24-91-103(1)(a) upon Initial Acceptance by Thornton.
- C. Contractor shall be responsible for the maintenance, security, heat, utilities, damages to the Work and insurance until the date of Initial Acceptance. In addition, Contractor shall be responsible for the provision of maintenance, security, heat, utilities, damages to the Work and insurance for the affected portion of the

Work during any period in which Contractor is called upon to perform corrective Work during the Warranty Correction Period.

- D. The Warranty Correction Period shall begin on the Date of Initial Acceptance. Thornton shall issue Initial Acceptance in writing, which shall set out the beginning and end dates for the Warranty Correction Period.

XVI. UTILITY LOCATIONS, RIGHT OF WAYS (ROW) & SERVICE

- A. Access to and Use of Right of Ways. Unless the Contract Documents provide that Contractor is to acquire property on behalf of Thornton, Thornton will furnish land and ROW as shown in the Contract Documents for the performance of the Work. Contractor shall confine its operations to the land and ROW furnished unless arrangements have been made in writing with other property owners and Thornton for access through or use of their property.
- B. Notice, Request for Utility Location, Easements. Contractor shall comply with C.R.S. §§ 9-1.5-101, et. seq., now and as amended hereafter, regarding location of utilities and utility easements. Contractor shall request a written record of any information from all owners or operators other than Thornton, of Underground Facilities as the statute requires regarding the location of the specific Underground Facilities. Contractor and all persons acting on behalf of Contractor shall comply with all the provisions of C.R.S. §§ 9-1.5-101, et. seq., applicable to notice, excavation and location of underground facilities.
- C. Utilities Information Provided "As Is." Thornton shall not be responsible for the accuracy or completeness of any information provided by third-party owners or operators of underground utilities and facilities, whether shown on the Contract Documents or located in the field. Contractor shall be responsible to determine the location of all underground utilities and facilities. Contractor shall include in the Contract Price the cost of such underground investigations, such as potholing.
- D. Identification of Utility(ies) Locations.
1. The center-line locations of underground utilities and facilities which are owned or operated by Thornton shall be located and shown on the Drawings. As part of the Work, Contractor shall, on behalf of Thornton, mark the actual location of such utilities and facilities on the Record Drawings to the extent the actual location varies from the location shown in the Drawings.
 2. In the event that the Drawings indicate that the location of any underground utilities or facilities are "unknown," "uncertain," or within a "range," Contractor shall have full responsibility for determining the exact location of such underground utilities and facilities by "potholing," "handwork," or such other means as may be necessary to determine the precise location without damaging them. The precise location of such underground utilities and facilities shall be incorporated into the Record Drawings.

3. Contractor shall notify Thornton immediately and request further direction if a utility or facility shown in the Drawings or marked in the field cannot be found by potholing or handwork within 18" horizontally from the exterior edges of the expected utility location.
4. If an underground utility or facility is uncovered or revealed, whether by field locates or by construction activities at or contiguous to the Project Site, which was not shown or indicated in the Drawings, Contractor shall promptly after becoming aware thereof and before further disturbing conditions affected thereby or performing any Work in conjunction therewith (except in emergency situations), notify Thornton of such underground utility or facility and give written notice of the discovery to the "Notification Association," and Thornton. The location of all such underground utilities and facilities shall be incorporated into the Record Drawings. Thornton will promptly review the underground utility or facility and determine the extent, if any, to which a change is required to reflect and document the consequences of its existence. During such time, Contractor shall be solely responsible for the safety and protection of such underground utility or facility.
5. Contractor shall ascertain and note on the Record Drawings all utilities, facilities, and utility easements' locations, whether initially shown correctly or incorrectly on the Contract Documents, and whether initially marked correctly, incorrectly or not at all in the field.

E. Utilities Location Associated Costs. The cost of all of the following shall be included in the Contract Price, and Contractor shall have sole responsibility for:

1. Reviewing and checking all information and data provided by all owners or operators of underground utilities and facilities;
2. Locating all underground utilities and facilities within 18" horizontally from the exterior edges of the expected utility location shown or indicated in the Drawings or marked in the field;
3. Coordination of the Work with the owners and operators of all underground utilities and facilities during construction; and
4. The safety and protection of all such underground utilities and facilities and repairing any damage thereto resulting from the Work.

F. Utility Service. Utility service shall be maintained to all areas at all times during construction of the Work, except when it is necessary to shut down a line to make a connection with a new line. All planned utility service interruptions shall be approved in advance in writing by Thornton. Affected tenants and property owners shall be given a minimum of twenty-four (24) hours written and verbal notice by Contractor when it is known that their service will be interrupted.

- G. Fire Hydrants. Contractor shall keep a sufficient clear area around all fire hydrants to permit their full and effective use in case of fire. The appropriate Fire Rescue Authority shall be kept advised of the status of all fire hydrants affected by any Work.

XVII. ROADS, TRAFFIC, TRAVEL CONTROL & MAINTENANCE

- A. Unless a road closure and detour are approved in advance by Thornton, adequate traffic flow shall be maintained at all times. All barricading and temporary signage for detours and traffic control must meet the standards as set forth in the most current edition of the Manual on Uniform Traffic Control Devices (“MUTCD”) as adopted by the Colorado Department of Transportation and as adopted by the United States Department of Transportation Federal Highway Administration and requirements of Thornton's designated traffic engineer. The cost of traffic control shall be included in the Contract Price. Public safety is Contractor's sole responsibility.
- B. Contractor is responsible for obtaining all necessary traffic control permits to conduct the Work.

XVIII. EMERGENCY PROTECTION

- A. After the Notice to Proceed has been issued and continuing through Initial Acceptance, the Contractor shall be solely responsible for protection and safety of the public and the Contractor's/Subcontractor's workers, twenty-four (24) hours a day, seven (7) days a week. Contractor shall also be solely responsible after Initial Acceptance when the Contractor is on the Project site performing any Warranty Work.
- B. Whenever, in the opinion of Thornton, the Contractor has not taken sufficient precaution for the safety of the public or the protection of the Work, or of adjacent structures or property, and whenever, in the opinion of Thornton, an emergency has arisen and immediate action is considered necessary, then Thornton, with or without notice to the Contractor, may provide suitable protection by causing Work to be done and Materials and Equipment to be furnished and placed. The cost of such Work and Materials and Equipment shall be borne by the Contractor, and if not paid on presentation of the bills, such costs will be deducted from any amounts due or that become due the Contractor. The performance of such emergency Work shall not relieve the Contractor of responsibility for any damage which may occur.

XIX. PROTECTION OF PUBLIC AND PRIVATE PROPERTY

- A. The Contractor shall make every effort to avoid damage to all public and private property, including, but not limited to, dikes, ditches, roadways, sidewalks, fences, trees, landscaping, structures, and utilities. Thornton assumes no responsibility whatsoever for any damage resulting from the Contractor's operations, whether such damage occurs on public or private property. The Contractor shall defend,

indemnify, and hold harmless Thornton from all claims for damage resulting from its operations. Any and all damages due to a disruption of utility service attributed to the Contractor's operations shall be the sole responsibility of the Contractor.

B. The Contractor shall contact any property owners verbally and in writing where additional access is needed to the Project site. Any damage to such property by the Contractor will be the responsibility of the Contractor. All claims must be settled before issuance of Final Payment.

C. Permits, Traffic Control Plan.

1. For all ROW requiring closure, Contractor shall obtain the appropriate permits for any Work therein from all applicable permitting authorities. Prior to the start of construction, Contractor shall submit to Thornton's Traffic Engineering Division the planned traffic control methods and procedures for the Work. The traffic control plan shall be approved by Thornton prior to implementation by Contractor. In general, except for alleyways, one (1) lane of the roadway for each direction must be kept open at all times or, if this cannot be achieved, sufficient flag persons must be provided to properly channel traffic at all times when there is only one (1) lane open.

2. In the event Work has commenced in a roadway or other area subject to vehicular traffic, including bicycles, Contractor shall provide and maintain access and safe travel conditions by ramping or surfacing with suitable materials to insure safe travel at all times.

D. Road Maintenance.

1. If, in the opinion of Thornton, the products used and/or the maintenance methods provided are not capable of safely supporting the anticipated vehicular traffic, Contractor shall either immediately remove the existing products and provide higher quality products, up to and including placement of temporary hot mix asphalt, increase the frequency of maintenance, or both, as may be directed by Thornton.

2. Failure to comply with this requirement may, at Thornton's sole discretion, result in the Work or a portion of the Work being suspended until the situation is corrected. Contractor shall not be entitled to additional compensation or an extension of the Contract Time because of its failure to provide proper road maintenance products. Should Contractor not perform any necessary patching and maintenance in a timely manner, Thornton may, at its option, have the Work performed by others and may deduct the cost from amounts due or that become due to Contractor.

3. The provision of products and their maintenance to assure access and safe travel shall be included in the Contract Price.

XX. COMPLIANCE WITH CURRENT LAWS

- A. All Work shall comply with all applicable Laws, rules, regulations, and codes of the United States and the State of Colorado and with the charter, ordinances, and rules and regulations of Thornton.

XXI. STOP WORK, SUSPENSION AND TERMINATION

A. Stop Work Order by Thornton

1. If in Thornton's opinion Contractor is persistently failing to carry out Work in accordance with the Contract Documents, Thornton may issue a written order to Contractor to stop the Work, or any portion of the Work, until the cause for such order has been eliminated; however, the right of Thornton to stop the Work shall not give rise to a duty on the part of Thornton to exercise this right for the benefit of Contractor or any other person or entity.
2. If Contractor defaults or neglects to carry out the Work in accordance with the Contract Documents, and fails within seven (7) Days after receipt of written notice from Thornton to commence and continue correction of such default or neglect with diligence and promptness, Thornton may, without prejudice to any other remedy Thornton may have, make good such deficiencies. In such case a Change Order shall be issued deducting from amounts then or thereafter due Contractor the cost to correct such deficiencies. If amounts then or thereafter due Contractor are not sufficient to cover such amount, Contractor shall pay the difference to Thornton upon demand.

B. Suspension by Thornton for Convenience

1. Thornton may order Contractor in writing to suspend, delay or interrupt all or any part of the Work without cause for its sole convenience.
2. With Thornton's reasonable discretion, adjustments caused by suspension, delay or interruption may be made as appropriate for increases in the Contract Price and/or the Contract Time. No adjustment shall be made if Contractor is or otherwise would have been responsible for the suspension, delay or interruption of the Work.

C. Termination by Thornton for Cause

1. If Contractor fails to supply enough qualified workers, proper Materials and/or Equipment, maintain the CPM Schedule, or fails to make prompt payment to its employees, Subcontractors or Material or Equipment Suppliers, disregards Laws or orders of any public authority having jurisdiction, or otherwise is in material breach of a provision of this Agreement, Contractor may be deemed in default. If Contractor fails within

seven (7) Days after receipt of written notice from Thornton to commence and continue correction of such default, Thornton shall give Contractor and the Surety a second written notice to correct the default within a three (3) Day period.

2. If Contractor fails to promptly commence and continue satisfactory correction of the default following receipt of such second notice, Thornton without prejudice to any other rights or remedies may: (a) take possession of the Project Site; (b) complete the Work utilizing any reasonable means; (c) withhold payment due to Contractor; and (d) as Thornton deems necessary, supply workers and Materials, Equipment and other facilities for the satisfactory correction of the default, and charge Contractor the costs and expenses, including reasonable overhead, profit and attorneys' fees.
3. In the event of an emergency affecting the safety of persons or property, Thornton may immediately commence and continue correction of a default without first giving written notice to Contractor but shall give prompt written notice to Contractor following commencement of the corrective action.
4. If Contractor files a petition under the bankruptcy code, this Agreement shall terminate if Contractor or Contractor's trustee rejects this Agreement, or if there has been a default and Contractor is unable to give adequate assurance that Contractor will perform as required by this Agreement or otherwise is unable to comply with the requirements for assuming this Agreement under the applicable provisions of the bankruptcy code.
5. If Thornton exercises its rights under this Agreement to terminate this Agreement, Thornton shall provide an accounting of the costs incurred by Thornton to Contractor and the Surety.
6. If Thornton terminates this Agreement for default, and it is later determined that Contractor was not in default or that the default was excusable under the terms of the Agreement, the termination shall be deemed a termination for convenience, and the rights of the Parties shall be as set forth herein.

D. Termination by Thornton for Convenience, Notice and Contractor's Claim

1. Thornton may terminate this Agreement for its own convenience. In such event, termination by Thornton for convenience shall be initiated by written notice to Contractor which will specify the effective date of the termination.
2. Contractor, after receiving the notice, shall cancel any outstanding commitments for procurement of Materials and Equipment. In addition, Contractor shall use reasonable efforts to cancel or divert any outstanding subcontracted commitments, unless otherwise requested by Thornton. With respect to such canceled commitments Contractor shall:

- a. Settle all outstanding liabilities and all claims arising out of the canceled commitments. Such settlements shall be approved by Thornton and shall be final; and
 - b. If requested by Thornton, assign Thornton all of the rights, title, and interest of Contractor under the terminated orders and Subcontracts, as directed by Thornton. Thornton will then have the right but not the obligation to settle or pay any or all claims arising out of the termination of these commitments.
3. Contractor shall submit its termination claim to Thornton within ninety (90) Days after the effective date of the notice. During the ninety (90)-Day period, Contractor may make a written request to Thornton for a time extension in preparing the claim. Any time extension must be approved by Thornton. If Contractor fails to submit its termination claim within the time allowed, Thornton may determine the amount due Contractor, if any, by reason of the termination, which determination shall be final. Failure of Contractor to submit a termination claim within the time allowed shall constitute a waiver of the claim.
4. Contractor and Thornton may agree upon the whole or any part of the amount to be paid Contractor as a result of the termination. The amount may include actual charges incurred by Contractor. The amount may also include any actual loss upon outstanding commitments for subcontracts which Contractor is unable to cancel, provided Contractor has proven reasonable effort to divert the commitments to other activities. The amount agreed upon shall be set forth in a Change Order, and Contractor shall be paid that amount. Contractor shall not be entitled to compensation for uncompleted Work or anticipated overhead and profit from the uncompleted portion of the Work.
5. Contractor shall transfer title and deliver to Thornton such items which, if the Agreement had been completed, would have been furnished to Thornton including:
 - a. Completed and partially completed Work; and
 - b. Materials or Equipment produced, acquired, or in the process of being produced that is terminated by the notice.
6. Other than the above, any termination inventory resulting from the termination may, with written approval of Thornton, be sold or acquired by Contractor under the conditions prescribed by and at prices approved by Thornton. The proceeds of any such disposition shall be applied to reduce any payments owed to Contractor, or shall be credited to the Cost of Work, or paid in a manner as directed by Thornton. Until final disposition,

Contractor shall protect and preserve all Materials and Equipment which is in its possession and in which Thornton has or may have an interest.

7. Contractor agrees to make its cost records available to Thornton to the extent they are necessary to determine the validity and amount of each item in the termination claim.
8. Termination of this Agreement, or a portion thereof for any reason, shall not relieve Contractor of contractual responsibilities for the Work completed, nor shall it relieve the Surety of its obligation for and concerning any claim arising out of Work performed.

E. Termination by Contractor

1. If the Work has been stopped for a consecutive thirty (30)-Day period, upon seven (7) Days written notice to Thornton, Contractor may terminate this Agreement for the following reasons:
 - a. Under court order or order of other governmental authorities having jurisdiction; or
 - b. As a result of the declaration of a national emergency or other governmental act during which, through no act or fault of Contractor, Materials or Equipment are not available.

F. Effect of Termination. Upon termination by Contractor in accordance with this section, Contractor shall be entitled to recover from Thornton payment for all Work executed and for all proven cost or expense incurred in connection with the Work, plus actual demobilization costs. Contractor shall not be entitled to compensation on Work not performed.

G. Contingent Assignment of Subcontract. If the Agreement is terminated for cause or convenience, Contractor shall terminate all contracts with its Subcontractors, subject to the prior rights of the Surety, provided that:

1. The Agreement is terminated by Thornton pursuant to the requirements herein; and
2. Contractor shall cause all appropriate Subcontractor information, documentation and subcontracts to be provided to Thornton in the event of termination.

XXII. TAXES

A. Contractor is obligated to pay federal and state income tax on any monies earned pursuant to this Agreement.

- B. Contractor shall determine which jurisdiction taxes are waived for governmental projects. Contractor shall be liable for exempt taxes paid due to the failure to apply for exemption certificates or failure to use them.
- C. Contractor shall furnish Thornton, upon request, duplicate receipts or other satisfactory evidence showing or certifying to the proper payment of all required licenses and taxes. Contractor shall promptly pay, when due, all bills, debts, and obligations they incur in the Contract funds, or performing the Work and shall allow no lien, mortgage, judgment or execution to be filed against land, facilities or improvements owned by Thornton.
- D. Tax Exempt Status.
 - 1. Thornton represents that it is exempt from Colorado State and Thornton sales and use taxes on Materials and Equipment to be permanently incorporated into the Work. No taxes of any kind shall be charged to Thornton. Said taxes shall not be included in the Contractor's Bid Proposal or the Contract Price. Contractor shall pay all sales, consumer, use, or other similar taxes required to be paid in accordance with the laws and regulations applicable to the Work.
 - 2. Contractor shall apply to the Colorado Department of Revenue for an exemption certificate and purchase the Materials and Equipment tax free (Section 39-26-104, C.R.S. as amended). Contractor shall be liable for exempt taxes paid due to the failure to apply for exemption certificates or failure to use them.

XXIII. CONFIDENTIALITY

- A. Unless compelled by law, a governmental agency or authority, an order of a court of competent jurisdiction or a validly issued subpoena, Contractor shall treat as confidential and not disclose to third-persons, except Subcontractors, Material Suppliers and Equipment Suppliers as is necessary for the performance of the Work, any reports or other data provided by Thornton or which Contractor may acquire in connection with the Project. All confidential information shall be returned to Thornton at the end of the Project.
- B. Thornton and Contractor shall specify those items to be treated as confidential by the other Party and shall mark them "Confidential." Contractor shall hold Thornton harmless from any claims arising from the release of confidential and proprietary information not clearly designated as such by Contractor or that is compelled to be released by Laws, a governmental agency or authority, an order of a court of competent jurisdiction or a validly issued subpoena.

- C. In the event a third party seeks disclosure of any Confidential Information from Contractor or Thornton, that Party shall promptly notify the other Party to permit that Party's objection.

XXIV. WATER

- A. Use. All water used by Contractor for testing, compaction, dust control or other uses related to construction of the Work shall be recorded by a meter furnished by Thornton, and the water shall be obtained from a location specified by Thornton. A refundable deposit for meter use shall be paid to Thornton's water utility by Contractor. Water use shall be metered and will be furnished by Thornton at no charge to Contractor. Contractor shall be responsible for paying a monthly water meter rental charge. The rental charge will be included in the Contract Price. The meter is required to be returned to Thornton every six (6) months for maintenance and calibration. If there are any damages to the meter and/or any missing parts, the cost of repair and/or replacement of parts will be deducted from Contractor's deposit.
- B. Contractor shall keep natural drainage and water courses unobstructed or provide other equal courses effectively placed.

XXV. ETHICS, NO FINANCIAL INTEREST, CONFLICTS AND RELATIONSHIPS

- A. Contractor agrees that it and its subsidiaries, affiliates, principals, employees and Subcontractors shall not engage in any transaction, activity, or conduct which would result in a conflict of interest. Contractor represents it has disclosed any and all current or potential conflicts of interest to Thornton. A conflict of interest shall include transactions, activities or conduct that would affect the judgment, actions or Work of Contractor by placing Contractor's own interests, or the interest of any party with whom Contractor has a contractual arrangement, in conflict with those of Thornton. Thornton, in its sole discretion, shall determine the existence of a conflict of interest and may terminate this Agreement in the event such a conflict exists after it has given Contractor written notice which describes the conflict. Contractor shall have twenty (20) Days after the notice is received to eliminate or cure the conflict of interest in a manner acceptable to Thornton.
- B. Disclosure of Pecuniary Relationships Required.
1. If any of the design or construction costs to be reimbursed arise from a transaction between Contractor and a Related Party, Contractor shall notify Thornton of the specific nature of the contemplated transaction, including the identity of the Related Party and the anticipated cost to be incurred, before any such transaction is consummated or cost incurred.
 2. If Thornton, after such notification, authorizes the proposed transaction, then the cost incurred shall be included the Contract Price, and Contractor may procure the Work, Materials, Equipment, goods or service from the Related Party. If Thornton fails to authorize the transaction, Contractor shall

procure the Work, Materials, Equipment, goods or service from some person or entity other than a Related Party.

- C. Contractor warrants that it has not and shall not pay or receive any contingent fees or gratuities to or from any Party, including its agents, officers, employees, Subcontractors, Suppliers, and others for whom they may be liable, in order to obtain preferential treatment.
- D. No Conflict of Interests. Contractor shall not retain any Subcontractor to perform Work under this Agreement if Contractor is aware, after a reasonable written inquiry has been made, that it is connected with the sale or promotion of Equipment or Material which is or may be used on the Project or any other conflict of interest exists, but in certain circumstances Thornton may permit a waiver in writing provided Contractor has fully disclosed any potential conflict of interest.

XXVI. DISPUTE RESOLUTION

- A. Unless otherwise agreed in writing, Contractor shall continue to perform the Work and maintain the CPM Schedule during any dispute or dispute resolution proceedings. If Contractor continues to perform, Thornton shall continue to make payments in accordance with this Agreement.
- B. The Parties shall attempt to resolve disputes among the Parties' Representatives.
- C. If either Party claims that attempts to resolve a dispute among the Parties' Representatives, has reached an impasse, the Representative for each Party shall refer the dispute to senior management of the respective Parties to endeavor to reach resolution through good faith direct discussions. Such senior management representatives shall possess the necessary authority to resolve such dispute. If the dispute remains unresolved after a reasonable period of time after discussions among the senior management representatives, the Parties may submit the dispute to mediation, which shall be held in the City of Thornton. The Parties shall share equally in the mediator's fees.
- D. If the attempted negotiation and mediation are unsuccessful, the Parties may proceed to litigation.
 - 1. Any legal action concerning or arising out of this Agreement shall be brought in the District Court, County of Adams, State of Colorado.
 - 2. Any action arising out of or relating to this Agreement or the Work asserted by Contractor against Thornton shall be brought within two (2) years from when the action accrued pursuant to C.R.S. § 13-80-102(h), as may be amended.
- E. This Agreement shall be governed by the Laws of the State of Colorado notwithstanding its choice of law principles.

XXVII. MISCELLANEOUS

- A. Assignments. The Contractor shall not assign the whole or any part of the Contract or any monies due or to become due thereunder without the written consent of Thornton and of the Surety on the Contractor's Bonds. A copy of the consent of the Surety, together with a copy of the assignment, shall be filed with Thornton. If the Contractor assigns all or any part of any monies due or to become due under the Contract, the instrument of assignment shall contain a clause to the effect that it is agreed that the right of the assignee in and to any monies due or to become due to the Contractor under the Contract shall be subject to prior claims and liens of all persons, firms, and corporations for services rendered; for the payment of all Materials and Equipment furnished; for payment of all Construction Equipment used or rented in the performance of the Work; and for the payment of any liens, claims, or amounts due federal, state, or local governments or any of their special enterprises.
- B. Authority of Thornton. Thornton, or its consulting Engineer, shall furnish engineering services during construction of the Work to the extent provided in the Contract Documents. Thornton or its consulting Engineer shall observe and review the Work during construction. Compliance with the Contract Documents shall be solely the Contractor's responsibility, notwithstanding such observation, or review. Thornton may suspend the Work when it appears such suspension may be necessary to accomplish the proper implementation of the intent of the Contract Documents.
- C. Computation of Times. When any period of time is referred to in the Contract Documents by days, it will be computed to exclude the first and include the last day of such period. If the last day of any such period falls on a Saturday or Sunday or on a day made a legal holiday by the law of the applicable jurisdiction, such day will be omitted from the computation.
- D. Survival of Obligations. All representations, indemnifications, warranties, and guarantees made in, required by, or given in accordance with the Contract Documents, as well as all continuing obligations indicated in the Contract Documents, will survive final payment, completion, and acceptance of the Work or termination or completion of the Contract or termination of the services of Contractor.

THIS PAGE INTENTIONALLY LEFT BLANK

EXHIBIT C

DRAWINGS AND SPECIFICATIONS

City of Thornton Zadel Reservoir Fencing, Project No. 18-554

Specifications:

Location: Northwest corner of Weld County Road 18 & Weld County Road 25 intersection.

Scope:

Install 9,635-LF of seven (7) foot 9-Gage Galvanized Chain Link Fence, 1-inch mesh with top and bottom tension wire. Bracing at all terminals and three strand of Barb Wire Top.

Install 24-foot wide double drive gate with standard hinges and lockable latch.

SECTION 607 – FENCES

DESCRIPTION:

607.01 This work consists of the construction of fence and gates per these specifications and in conformity with the lines and grades shown on the plans or established.

MATERIALS:

607.02 Materials shall meet the requirements specified in the following subsections:

Barbed Wire CDOT Specification 710.01

Chain Link Fabric CDOT Specification 710.03

Steel Fence Posts CDOT Specification 710.07

Reinforcing steel shall conform to CDOT Specification Section 602.

Concrete shall conform to CDOT Specification Section 601.

Foundation concrete for fence posts, braces, anchors, and gates shall be Class B. Concrete with lightweight aggregates conforming to ASTM C330 will be permitted. Field mixed concrete consisting of a minimum of one part cement to six parts of aggregate by volume may be used in lieu of Class B if approved. Pre-packaged concrete may be used if approved.

CONSTRUCTION REQUIREMENTS

607.03 The Contractor shall perform such clearing and grubbing as may be necessary to construct the fence to the required grade and alignment.

The fence shall be constructed approximately 6-inches inside the boundary of the reservoir right of way shown on the plans and staked by the city. Anchorages, footings or fence appurtenances shall not extend beyond the limits of the highway right of way.

When the plans require that posts, braces, or anchors be embedded in concrete, they shall be securely braced to hold the posts in proper position until the concrete has set sufficiently to hold the posts. Unless otherwise permitted, materials shall not be installed on posts, or stress placed on guys and bracing set-in concrete until the concrete has set sufficiently to withstand the stress.

The tops of all posts shall be set to the required grade and alignment. Cutting of the tops or bottoms of treated timber posts will be allowed only with the approval of the Engineer. Posts cut in the field shall have the cut surfaces protected with two coats of an approved wood preservative.

Wire or fencing of the size and type required shall be firmly attached to the posts and braces in the manner indicated. All wire shall be stretched taut and be installed to the required spacing.

METHOD OF MEASUREMENT

607.04 Fence will be measured by the linear foot. Measurement will be along the base of the fence from outside to outside of end posts for each continuous run of fence, excluding the length of driveway gate.

Driveway gates will be measured as complete units of the size and type specified. Gates shall be the same type and height as the adjacent fence unless otherwise designated.

End posts, corner posts, and line brace posts required for chain link fence, barbed wire, and combination wire fence will not be measured.

Line posts required for the new fence will not be measured separately but shall be included in the contract unit price for new fence.

Measurement will be along the base of the fence from outside to outside of end posts for each continuous run of fence, and shall include all, hardware, concrete, reinforcing steel, excavation and backfill, and all other incidentals to the erection of the fence.

BASIS OF PAYMENT

607.05 The accepted quantities of fence will be paid for at the contract unit price for each of the pay items listed below that appear in the bid schedule.

Payment will be made under:

Pay Item Pay Unit

7-foot Chain Link Fence	Linear Foot
24-foot Double Gate	Each

PLANS, CROSS SECTIONS AND STANDARDS

FENCE AND SOUTH PARCEL BOUNDARY
LOCATED MINIMUM 3 FT FROM
TOP OF LITTLE DRY CREEK BANK

SOUTH CELL

KPK WELL

KERR McGEE
WELL

FUTURE
200' x 200'
PUMP STATION
PAD

KPK WELL

KERR McGEE
WELL

PROPOSED SOUTH
PARCEL BOUNDARY

EX IRRIGATION PIPE

WCR 18

WCR 25

20' WIDE
ACCESS ROAD

LEGEND:

- PROPERTY LINE
- - - RELOCATED PIPES
- - - UNITED POWER EXISTING ELECTRIC LINES
- - - EXISTING GAS
- - - EXISTING FENCE
- - - EXISTING IRRIGATION PIPE
- - - EXISTING CONTOURS
- - - PROPOSED CONTOURS
- WETLAND VEGETATION
- PROPOSED GRAVEL ACCESS ROAD
- PROPOSED FENCE
- PROPOSED SOUTH PARCEL BOUNDARY

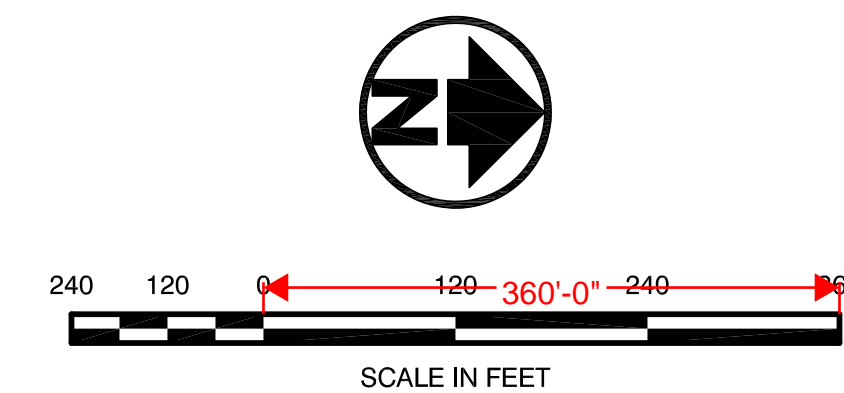

No.	Date	By	Chk	Description

P:\07121 NCCI Liner Design\Drawings\NCCI NCCI updated set - no north reservoir\JT-NCC Fence Plan.dwg, Fence, 10/4/2023 12:44:45 PM

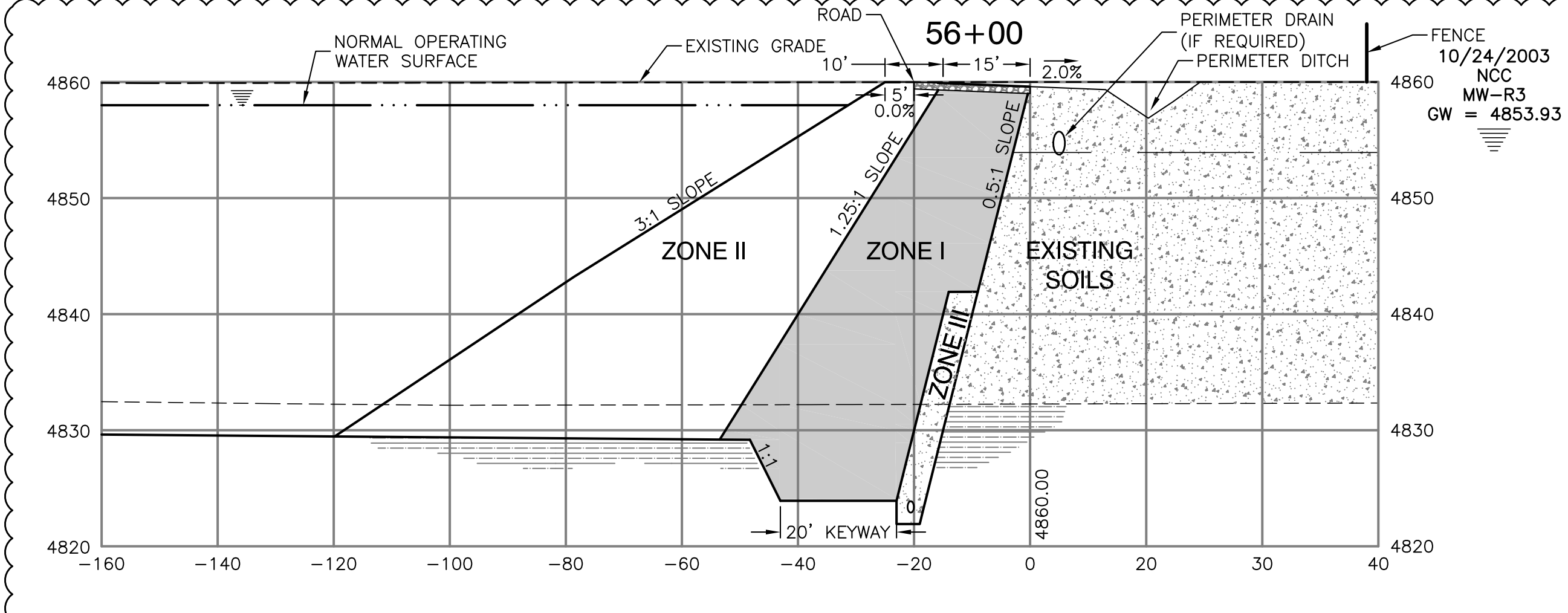
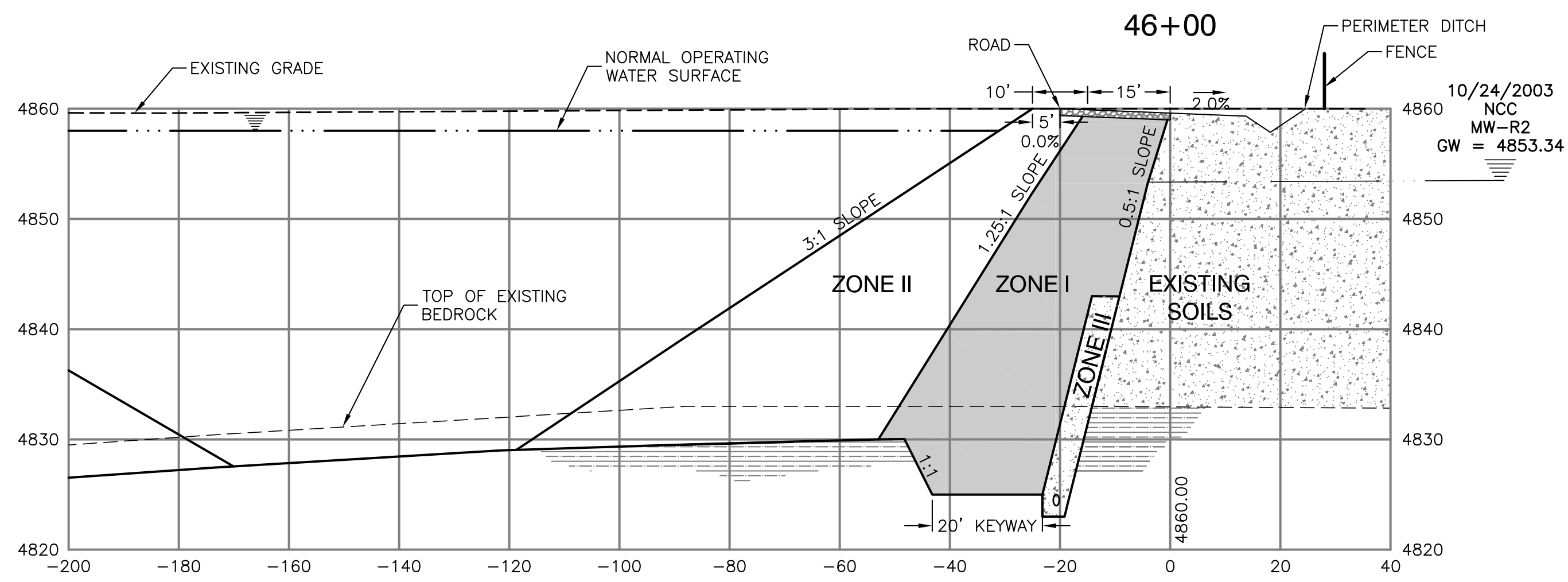

NOTE:
LIMITS OF EXCAVATION SHOWN ARE APPROXIMATE. EXCAVATE TO LIMITS DETERMINED IN THE FIELD BY ENGINEER.

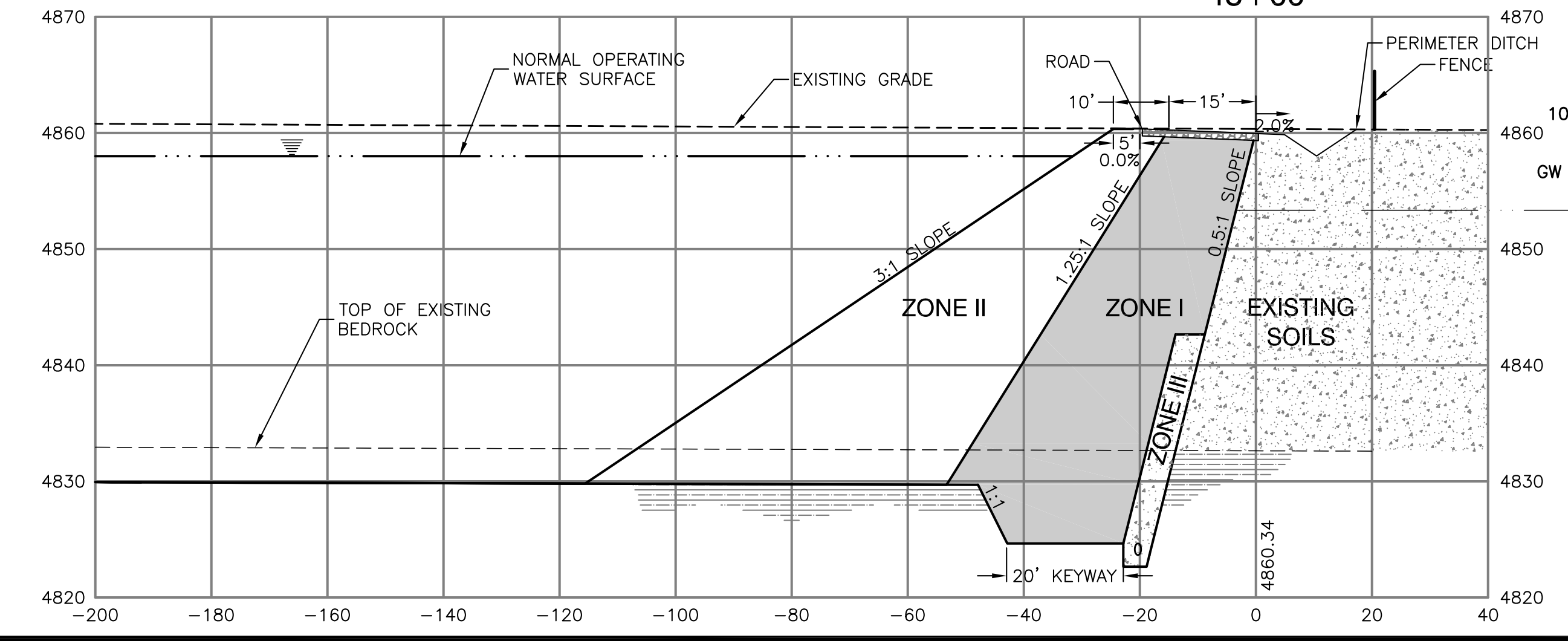
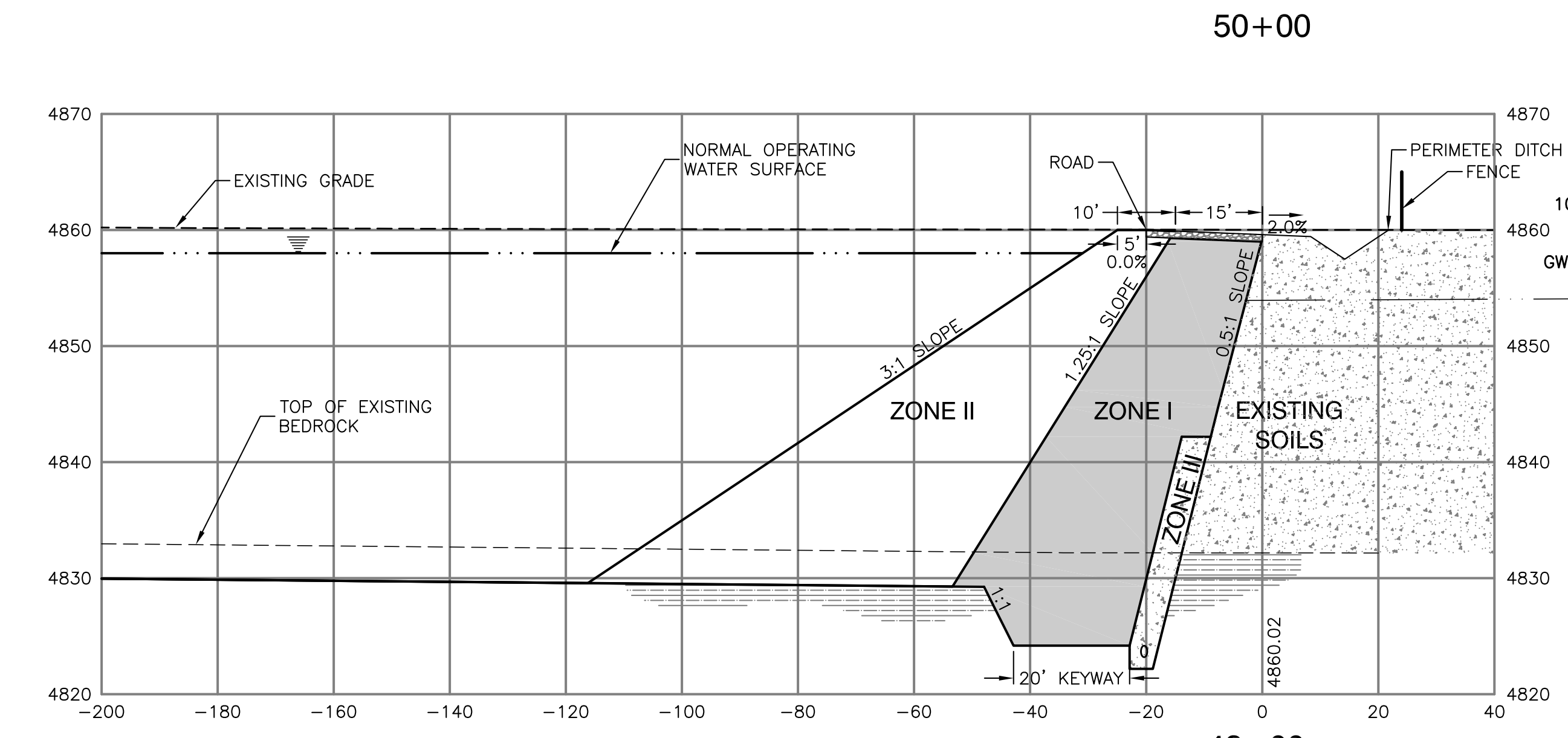
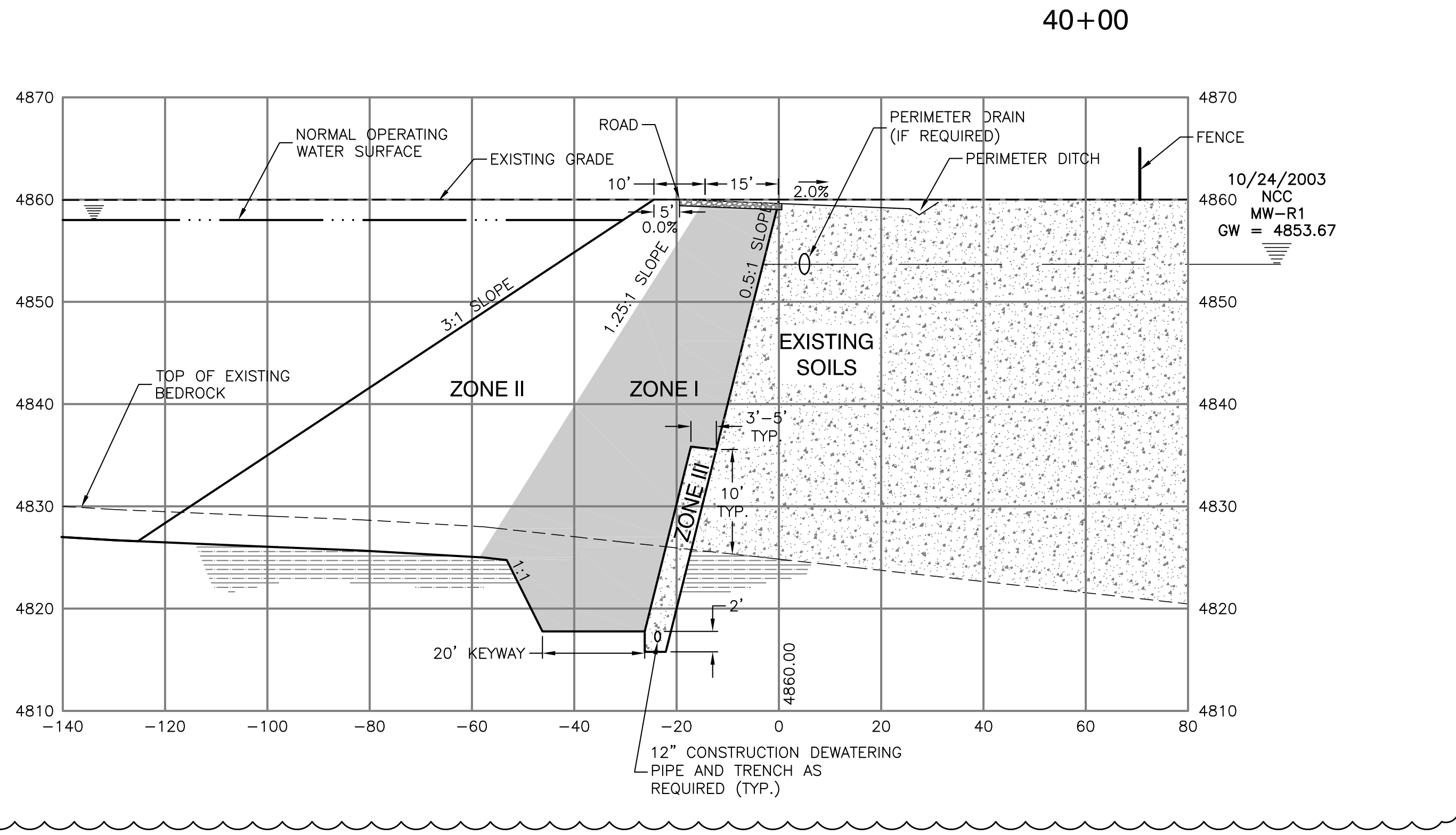
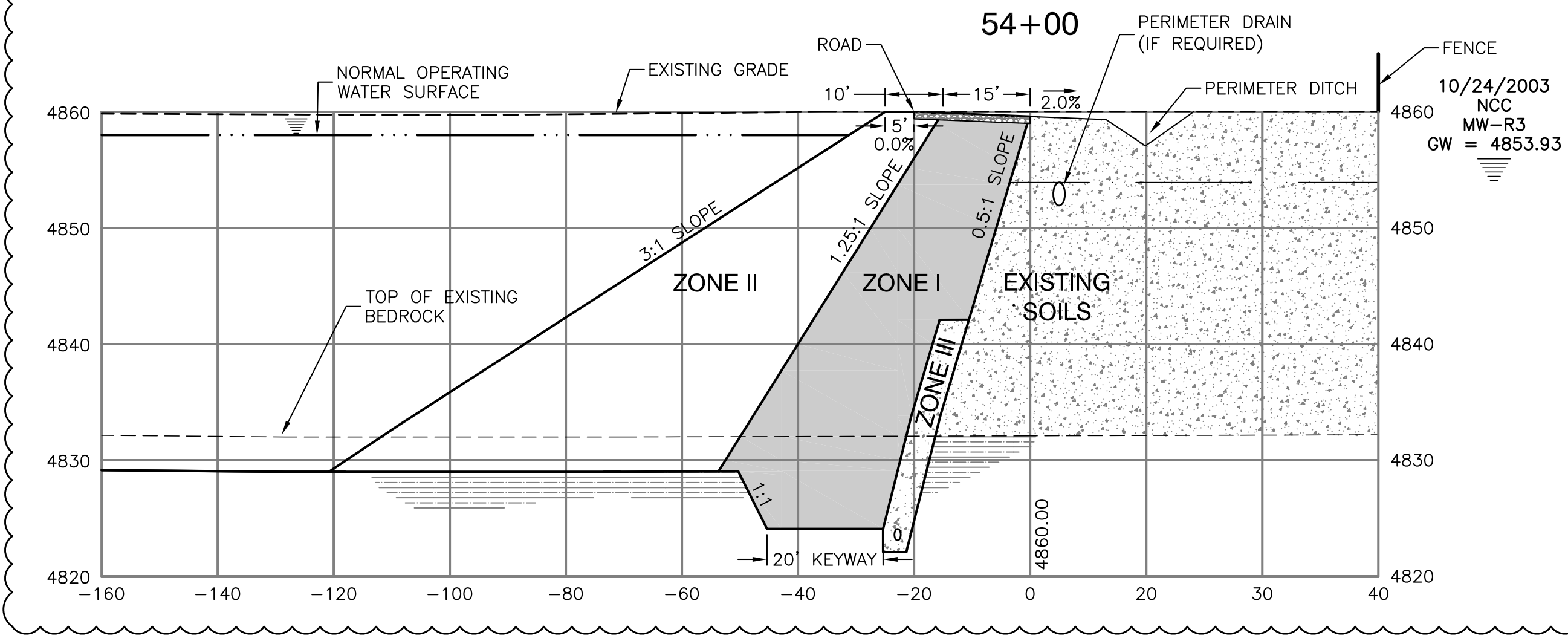
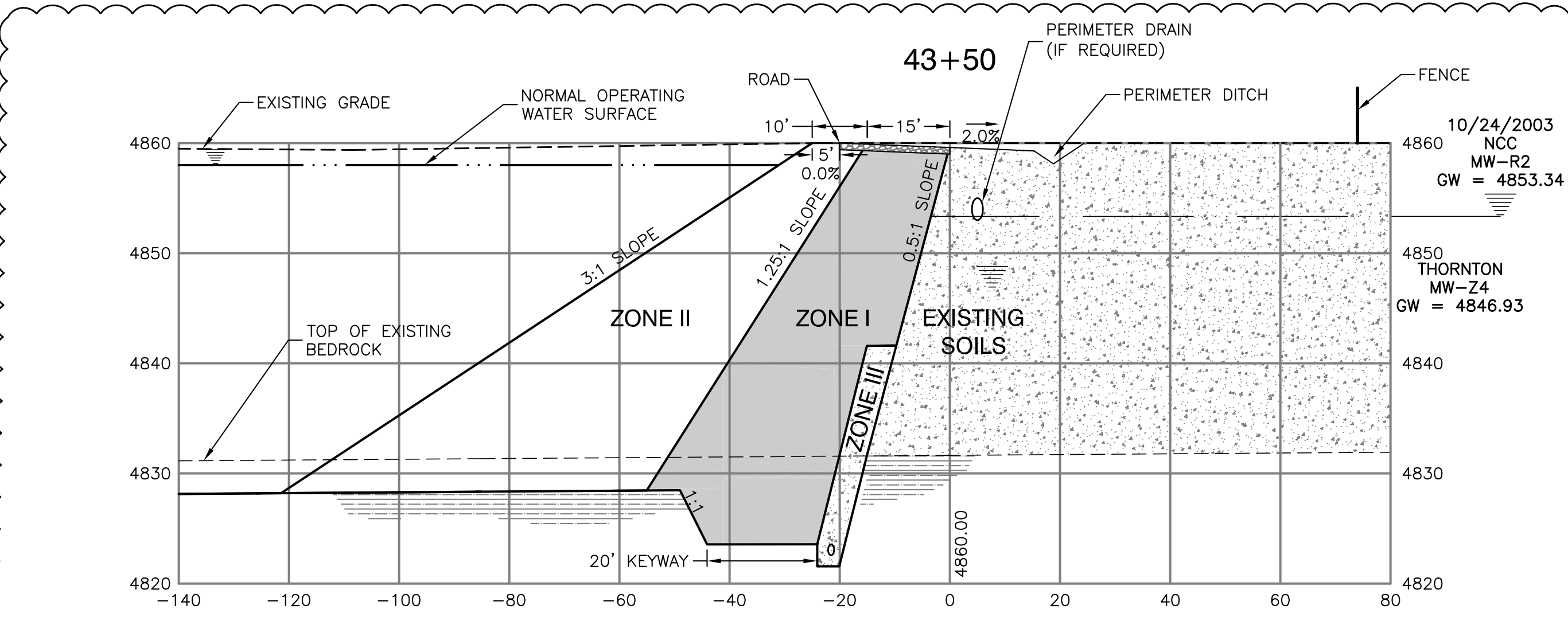

ISSUED FOR CONSTRUCTION

J&T Consulting, Inc.
305 Denver Avenue - Suite D
Fort Lupton, CO 80621
Ph: 303-857-6222 Fax: 303-857-6224
www.jtconsulting.com

Northern Colorado Constructors, Inc.
Reservoir Liner Construction Plans
South Cell
Cross - Sections
Sta: 40+00 to 56+00

NCC Pit #1

No	Date	By	Chk	Description
1	9/30/08	WSS	JCY	Issued For Construction
2	9/25/19	WSS	JCY	City of Thornton Comments
3	9/25/19	WSS	JCY	City of Thornton Comments
4	10/31/19	TWT	JCY	City of Thornton Comments
5	1/17/20	WSS	JCY	City of Thornton Comments
6	3/25/20	BDC	JCY	City of Thornton Comments
7	5/27/20	TPY	JCY	City of Thornton Comments
8	11/9/20	TPY	JCY	Revised Perimeter Drain Layout



Job # 07121
Date 4/24/08
Drawn By TPY/WSS
Designed By TPY
Checked By JCY
File JT-Xsecs
Scale 1" = 20'h/10'v

Sheet: **15** of **20**

P:\07121 NCC\ Liner Design\Drawings\CD\NCC 2020 updated set - no north reservoir\JT-Xsecs.dwg, 15 Cross - Sections, 10/11/2023 9:57:05 AM

GENERAL NOTES

1. AT EACH LOCATION WHERE AN ELECTRIC TRANSMISSION, DISTRIBUTION, OR SECONDARY LINE CROSSES A FENCE, THE CONTRACTOR SHALL FURNISH AND INSTALL A GROUND CONFORMING TO ARTICLE 250 OF THE NATIONAL ELECTRIC CODE. A GROUND SHALL ALSO BE INSTALLED A MAXIMUM OF EVERY 500 FT. ALONG THE FENCE. THE GROUND ROD SHALL BE A MINIMUM DIAMETER OF 1/2 IN. AND 8 FT. IN LENGTH, AND DRIVEN AT LEAST 7 1/2 FT. INTO THE GROUND. THE ROD SHALL BE CONNECTED TO EACH WIRE WITH A MINIMUM AWG NO. 8 STRANDED COPPER WIRE. GROUNDING WILL NOT BE PAID FOR SEPARATELY BUT SHALL BE INCLUDED IN THE COST OF THE FENCE.
2. H (HEIGHT OF FABRIC) SHALL BE AS SHOWN ON THE PLANS. FABRIC IS AVAILABLE IN THE FOLLOWING HEIGHTS: 36 IN., 42 IN., 48 IN., 60 IN., 72 IN., 84 IN., 96 IN., 108 IN., 120 IN., AND 144 IN.
3. CHAIN LINK FENCE SHALL CONFORM TO AASHTO M 181.
4. CHAIN LINK FABRIC SHALL BE 2 IN. MESH NO. 9 GAGE GALVANIZED OR ALUMINUM COATED WIRE SECURELY FASTENED TO TENSION WIRE, LINE POSTS, RAILS, BRACES AND STRETCHER BARS SPACED AS SHOWN HEREON. WIRE FASTENERS AND TIE CLIPS SHALL BE NO. 11 GAGE (W&M) GALVANIZED STEEL WIRE OR NO. 7 GAGE (B&S) ALUMINUM WIRE, AND HOG RINGS SHALL BE NO. 9 GAGE, ALL IN CONFORMANCE WITH ASTM F 626.
5. STEEL POSTS, RAILS AND GATE FRAMES SHALL CONFORM TO AASHTO M 181 TYPE 1, GRADE 2.
6. AT THE CONTRACTOR'S OPTION, PIPE USED FOR FENCE CONSTRUCTION SHALL CONFORM TO THE DIMENSIONS AND WEIGHTS FOR EITHER "ORDINARY PIPE" OR "ALTERNATIVE PIPE" AS SHOWN ON SHEET 2. "ALTERNATIVE PIPE" SHALL BE HIGH STRENGTH STEEL PIPE CONFORMING TO FEDERAL SPECIFICATION RR-F-191/3C.
7. TENSION WIRE SHALL BE CONTINUOUS BETWEEN END OR CORNER POST AND LINE BRACE POST. A TURNBUCKLE OR OTHER APPROVED TIGHTENING DEVICE SHALL BE USED FOR EACH CONTINUOUS SPAN OF TENSION WIRE.
8. TENSION WIRE SHALL CONFORM TO AASHTO M 181.
9. CONCRETE FOOTINGS SHALL HAVE TOPS CROWNED AT GROUND LEVEL AND SHALL BE CLASS B. CONCRETE WITH LIGHTWEIGHT AGGREGATE CONFORMING TO AASHTO M 195, MAY BE SUBSTITUTED.
10. TERMINATION OF FENCE AT BRIDGES OR OTHER STRUCTURES SHALL BE AS SHOWN ON THE PLANS.
11. CHAIN LINK FABRIC UP TO 5 FT. HIGH SHALL BE KNUCKLED AT THE TOP AND BOTTOM SELVAGES. FABRIC OVER 5 FT. HIGH SHALL BE TWISTED AND BARBED ON THE TOP SELVAGE AND KNUCKLED ON THE BOTTOM SELVAGE.
12. FENCE MAY BE CONSTRUCTED WITH EITHER ROUND PIPE OR ROLL-FORMED STEEL COMPONENTS. THE CONTRACTOR SHALL STATE AT THE PRECONSTRUCTION CONFERENCE, THE TYPE OF CONSTRUCTION AND TYPE OF LINE POST TO BE USED THROUGHOUT THE PROJECT.
13. THE CONTRACTOR SHALL BE RESPONSIBLE FOR RE-ESTABLISHING DISTURBED OR DESTROYED SURVEY MONUMENTS TO THE APPROPRIATE ACCURACY IN ACCORDANCE WITH SUBSECTION 625.08 OF THE STANDARD SPECIFICATIONS.

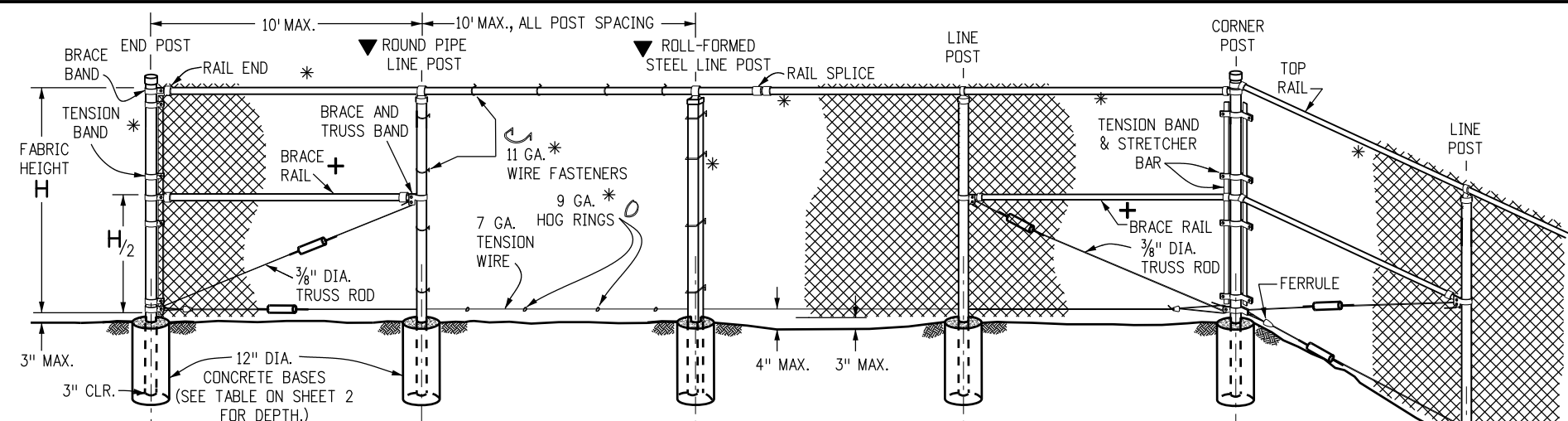

FENCE WITH TOP RAIL (USE ONLY AT SPECIAL LOCATIONS BEYOND CLEAR ZONE WHEN THE TOP RAIL IS SPECIFIED ON PLANS)

LEGEND

- * ATTACH FABRIC TO ALL FENCE & GATE STRUCTURES AT 12 IN. INTERVALS VERTICALLY AND AT 20 IN. HORIZONTALLY.
 - ▲ TIGHTENER OR TURNBUCKLE SYMBOL, (SEE DETAILS ON SHEETS 2 AND 3).
 - ▼ TYPE OF LINE POST (ROUND PIPE OR ROLL-FORMED STEEL) SHALL BE AT THE OPTION OF THE CONTRACTOR UNLESS OTHERWISE SHOWN ON THE PLANS.
 - + BRACE RAIL IS NOT REQUIRED FOR 36 IN., 42 IN., OR 48 IN. FABRIC HEIGHTS. BRACE RAIL FOR FENCE WITH ROLL-FORMED STEEL ELEMENTS IS 12 IN. BELOW THE TOP RAIL, (SEE SHEET 3).
- ★ CASE 1. TO KEEP INSIDERS IN, SLOPE TOP IN 45°
- ★ CASE 2. TO KEEP OUTSIDERS OUT, SLOPE TOP OUT 45° BARBED WIRE OVER GATES SHALL NOT BE SLOPED

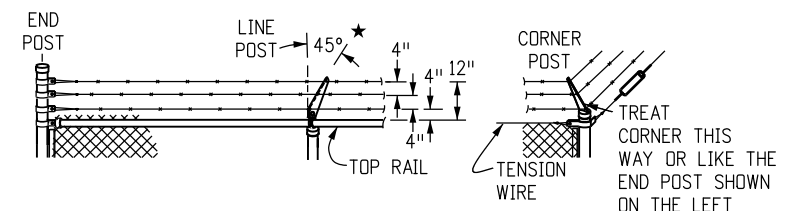

BARBED WIRE TOP (USE ONLY WHEN SPECIFIED ON PLANS)

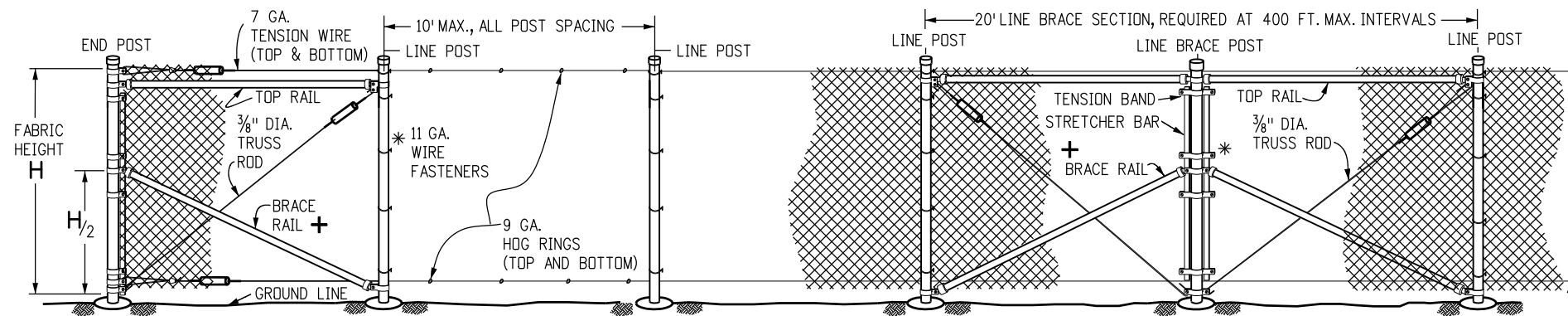

FENCE WITH TOP TENSION WIRE (USE FOR STANDARD CHAIN LINK FENCE)

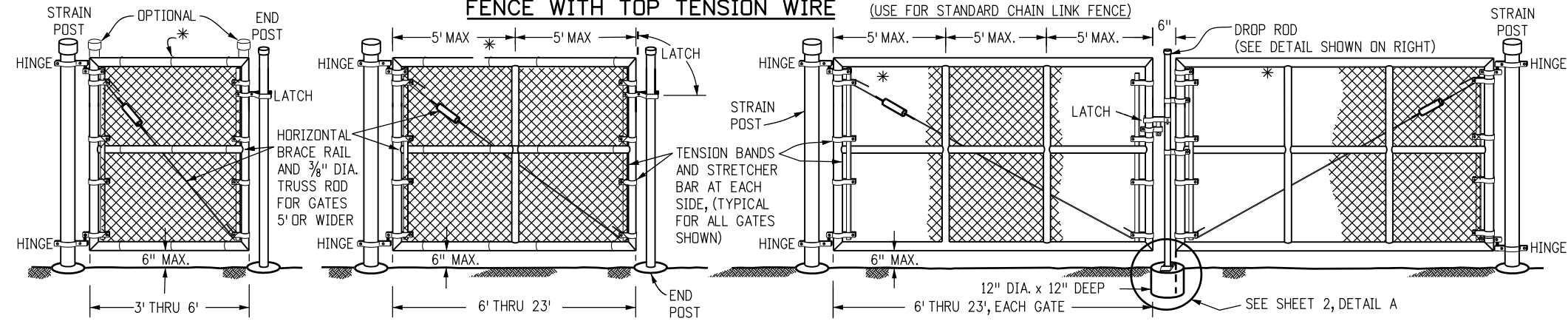

WALK GATE

SINGLE GATE

DOUBLE GATE

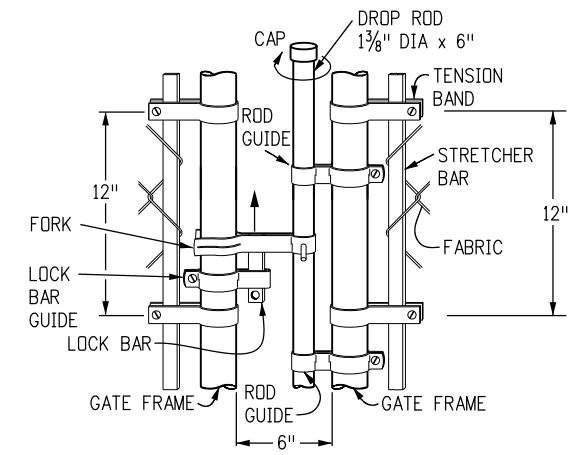

TYPICAL DROP ROD ASSEMBLY

Computer File Information		Sheet Revisions		Colorado Department of Transportation 2829 West Howard Place CDDT HQ, 3rd Floor Denver, CO 80204 Phone: 303-757-9021 FAX: 303-757-9868 Project Development Branch	<h1>CHAIN LINK FENCE</h1>	STANDARD PLAN NO.	
Creation Date: 07/31/19		Date:	Comments:			M-607-2	
Designer Initials: JBK		(R-X)				Standard Sheet No. 1 of 3	
Last Modification Date: 07/31/19		(R-X)					
Detailer Initials: LTA		(R-X)					
CAD Ver.: MicroStation V8 Scale: Not to Scale Units: English		(R-X)		JBK	Issued by the Project Development Branch: July 31, 2019	Project Sheet Number:	

FENCE MATERIAL

FABRIC HEIGHT	END, CORNER AND LINE BRACE POSTS		LINE POSTS		TOP & BRACE RAILS	
	ROUND PIPE I.D.	ROLL-FORMED STEEL	ROUND PIPE I.D.	ROLL-FORMED STEEL	ROUND PIPE I.D.	ROLL-FORMED STEEL
FEET	INCHES		INCHES		INCHES	
3 THRU 6	2.5	3.5 x 3.5	1.5	1.875 x 1.625	1.25	1.25 x 1.625
> 6 THRU 8	2.5	3.5 x 3.5	2.0	1.875 x 1.625	1.25	1.25 x 1.625
> 8 THRU 12	2.5	3.5 x 3.5	2.0	2.250 x 1.625	1.25	1.25 x 1.625

FABRIC HEIGHT	CONCRETE BASE			
	DEPTH		DIA.	
FEET	INCHES		INCHES	
3 THRU 4	34	12	28	12
> 4 THRU 12	40	12	40	12

△ ALL POSTS 3 IN CLEAR FROM BOTTOM OF CONCRETE BASE

ORDINARY PIPE

NOMINAL I.D.	O.D.	WALL THICK.	WEIGHT
INCHES			LB/FT
1.25	1.660	0.140	2.27
1.50	1.900	0.145	2.72
2.00	2.375	0.154	3.65
2.50	2.875	0.203	5.79
3.00	3.500	0.216	7.58
3.50	4.000	0.226	9.11
4.00	4.500	0.237	10.79
5.00	5.563	0.258	14.62
6.00	6.625	0.280	18.97
8.00	8.625	0.322	28.55

ALTERNATIVE PIPE

NOMINAL I.D.	O.D.	WALL THICK.	WEIGHT
INCHES			LB/FT
1.25	1.660	0.111	1.836
1.50	1.900	0.120	2.281
2.00	2.375	0.130	3.117
2.50	2.875	0.160	4.640

GATE MATERIAL

GATE FRAME WIDTH	STRAIN POST		CONCRETE BASE	
	ROUND I.D.	ROLL-FORMED	DEPTH	DIA.
FEET	INCHES		INCHES	
3 THRU 6	2.5	3.5 x 3.5	36	12
> 6 THRU 13	3.5	—	42	12
> 13 THRU 18	6.0	—	48	18
> 18 THRU 23	8.0	—	48	24

GATE FRAME		FRAME PIPE	BRACING PIPE
WIDTH	HEIGHT	I.D.	I.D.
FEET			
INCHES			
3 THRU 8	3 THRU 6	1.25	1.25
> 8 THRU 23	6	1.50	1.25
> 8 THRU 23	> 6 THRU 12	1.50	1.50

ROLL-FORMED STEEL

PART	SIZE	THICK.	WEIGHT
	INCHES	GAGE	LB/FT
TOP & BRACE RAILS	1.250 x 1.625	14	2.08
LINE POST (H: 3FT - 6FT)	1.875 x 1.625	12	2.75
LINE POST (H: > 6FT - 8FT)	1.875 x 1.625	11	3.36
LINE POST (H: > 8FT - 12FT)	2.250 x 1.625	11	4.02
END, CORNER & LINE BRACE POSTS	3.50 x 3.50	10	7.59

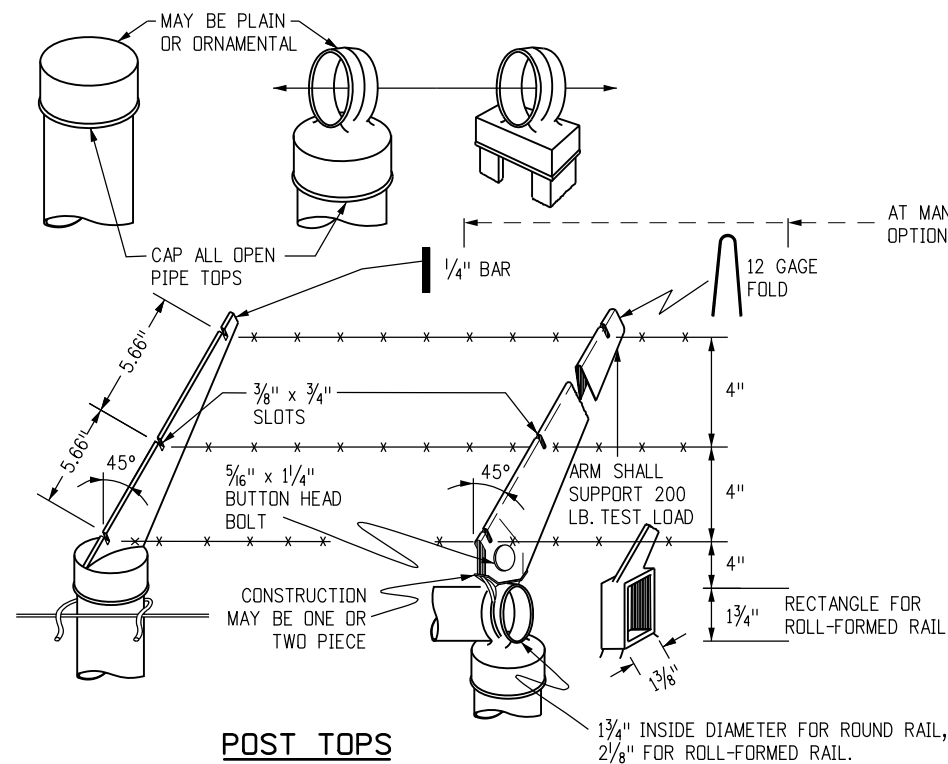

POST TOPS

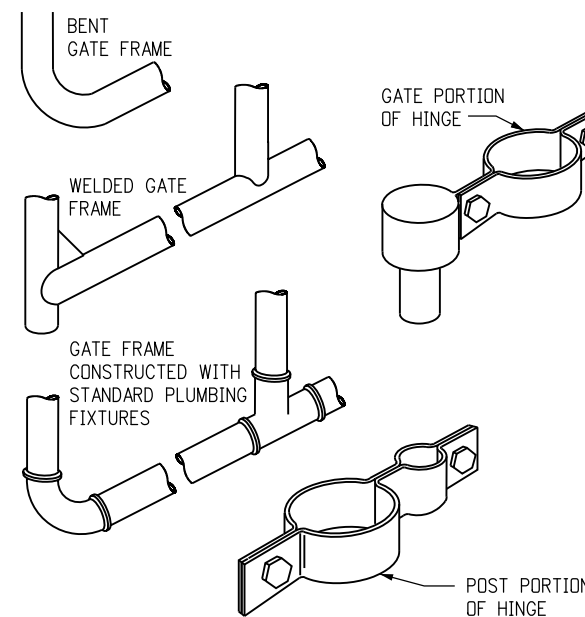

GATE FRAMES & HINGE

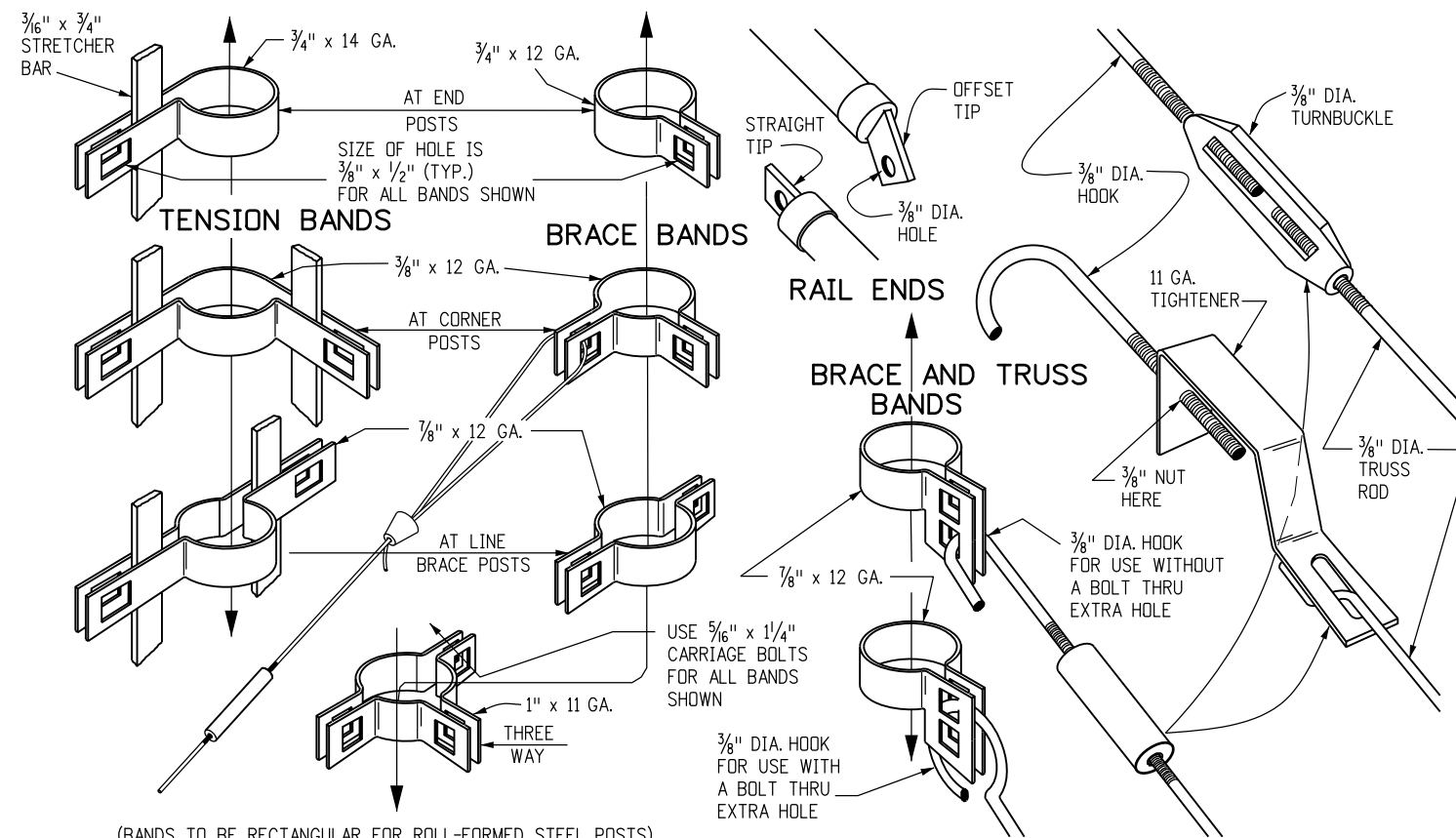

BANDS, RAIL ENDS & TIGHTENERS (DIMENSIONS SHOWN ARE MINIMUMS)

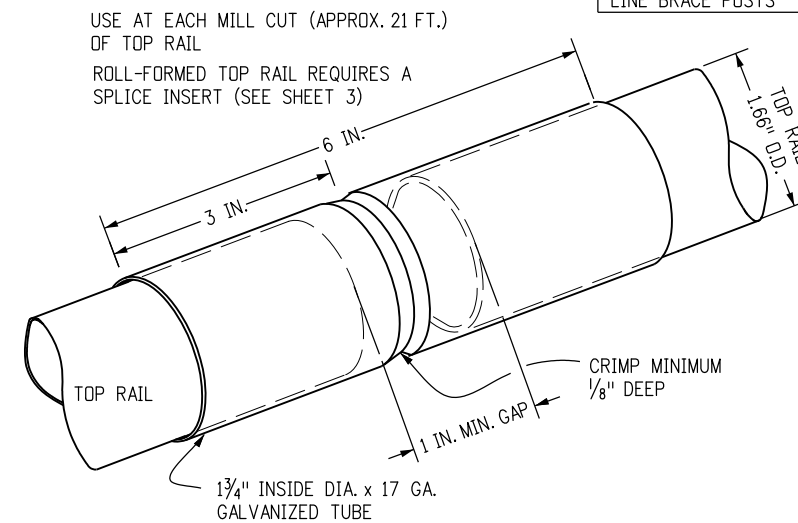

RAIL SPLICE

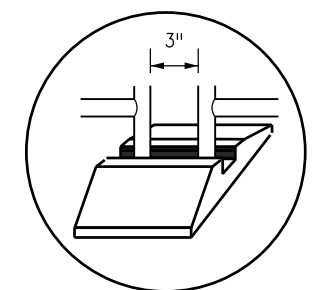

DETAIL A TYPICAL CENTER REST

Computer File Information

Creation Date: 07/31/19
Designer Initials: JBK
Last Modification Date: 07/31/19
Detailer Initials: LTA
CAD Ver.: MicroStation V8 Scale: Not to Scale Units: English

Sheet Revisions

Date:	Comments
(R-X)	
(R-X)	
(R-X)	
(R-X)	

Colorado Department of Transportation

2829 West Howard Place
 CDDT HQ, 3rd Floor
 Denver, CO 80204
 Phone: 303-757-9021 FAX: 303-757-9868

Project Development Branch

JBK

CHAIN LINK FENCE

Issued by the Project Development Branch: July 31, 2019

STANDARD PLAN NO.

M-607-2

Standard Sheet No. 2 of 3

Project Sheet Number:

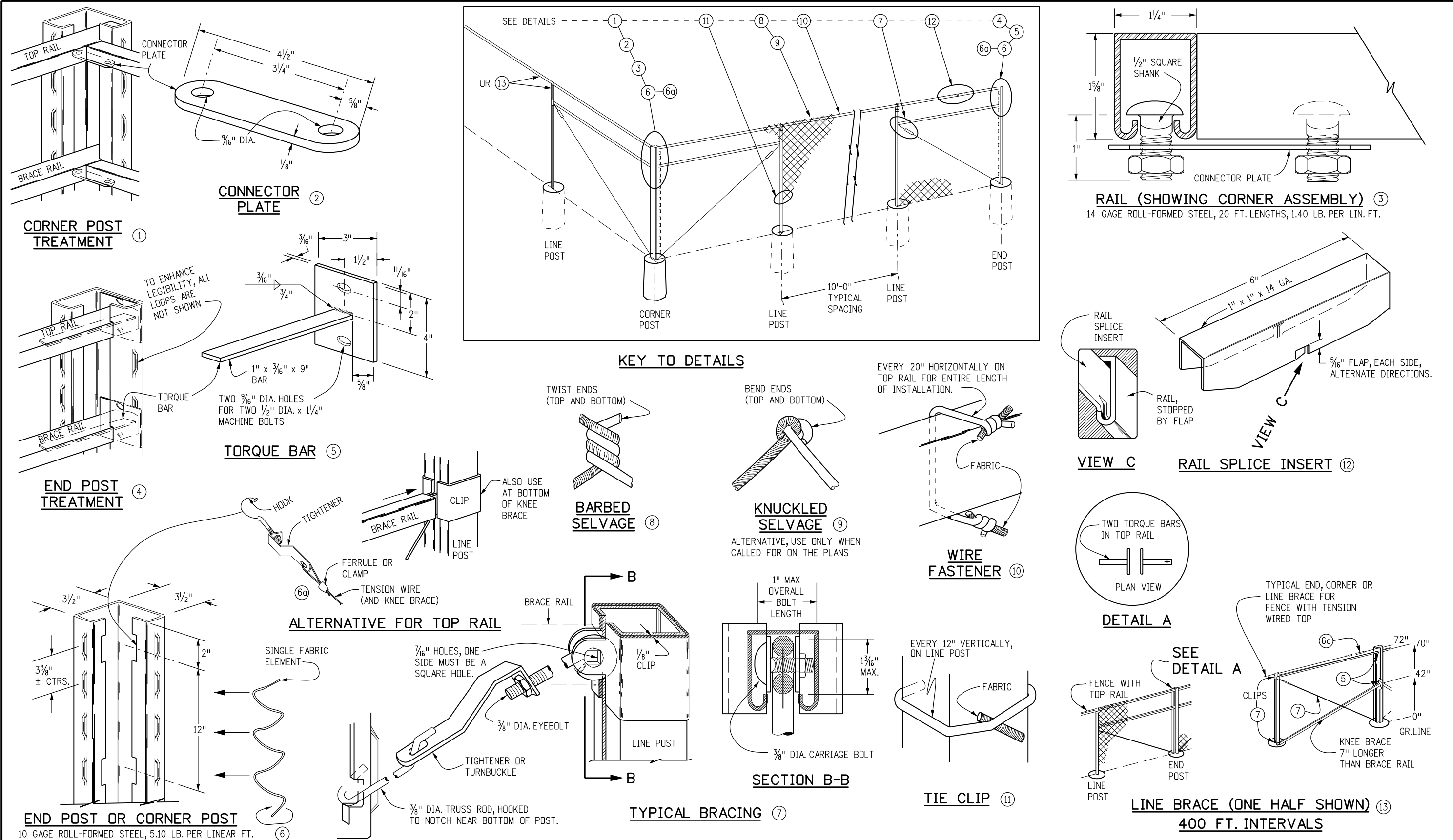

Computer File Information	
Creation Date:	07/31/19
Designer Initials:	JBK
Last Modification Date:	07/31/19
Detailer Initials:	LTA
CAD Ver.:	MicroStation V8
Scale:	Not to Scale
Units:	English

Sheet Revisions	
Date:	Comments
(R-X)	
(R-X)	
(R-X)	
(R-X)	

Colorado Department of Transportation
 2829 West Howard Place
 CDDT HQ, 3rd Floor
 Denver, CO 80204
 Phone: 303-757-9021 FAX: 303-757-9868
 Project Development Branch JBK

CHAIN LINK FENCE

Issued by the Project Development Branch: July 31, 2019

STANDARD PLAN NO.	
M-607-2	
Standard Sheet No. 3 of 3	
Project Sheet Number:	

NOTE:
LIMITS OF EXCAVATION SHOWN ARE APPROXIMATE. EXCAVATE TO LIMITS DETERMINED IN THE FIELD BY ENGINEER.

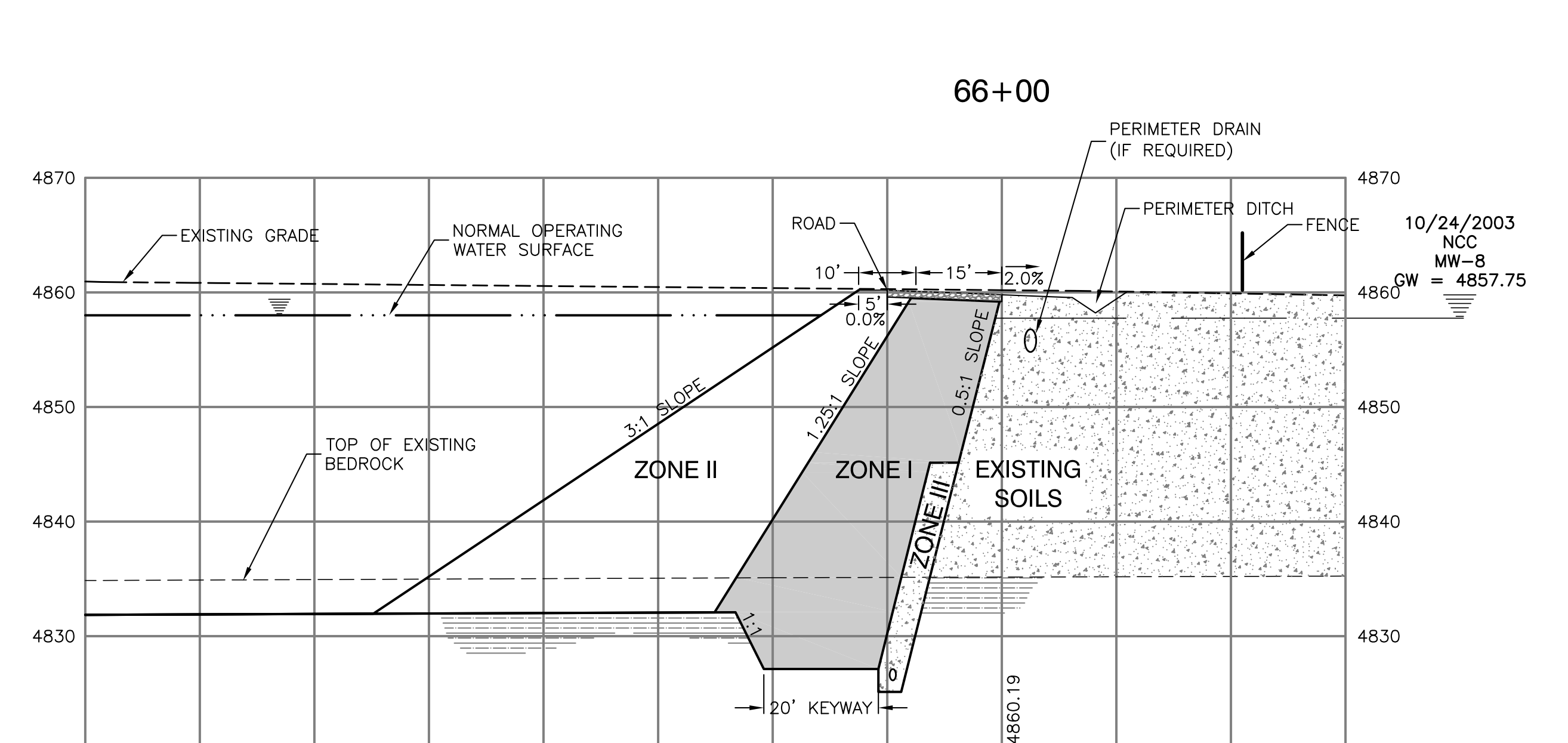
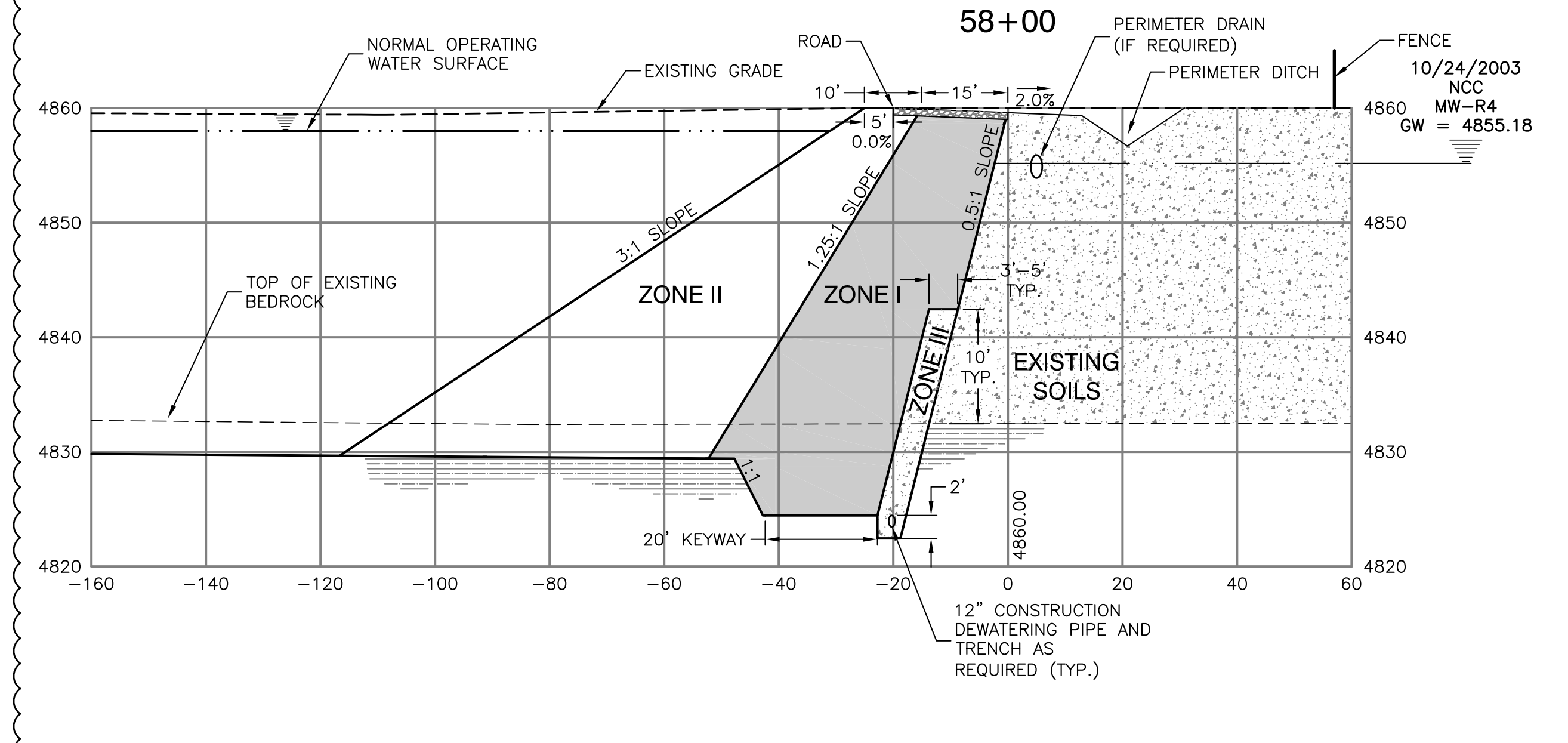
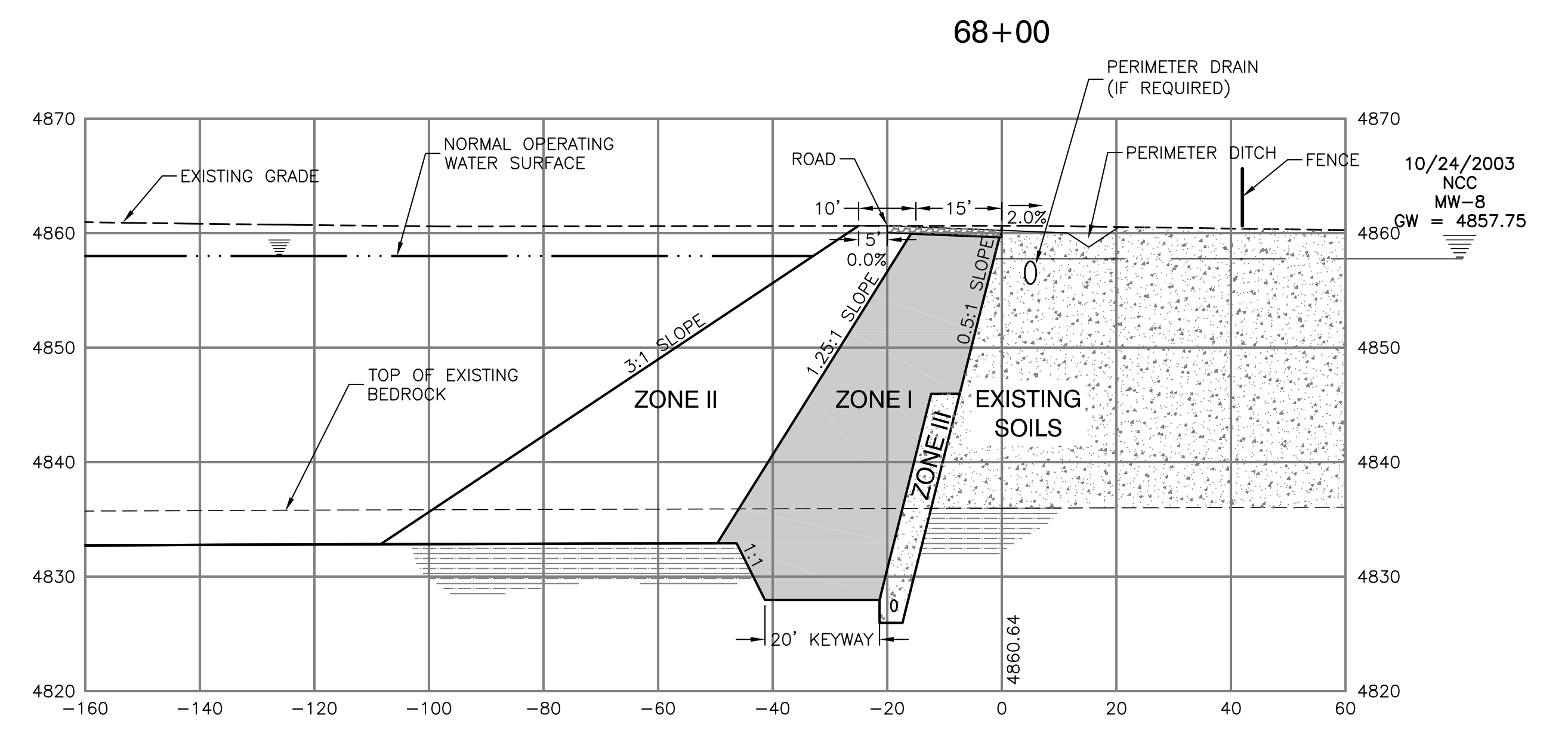
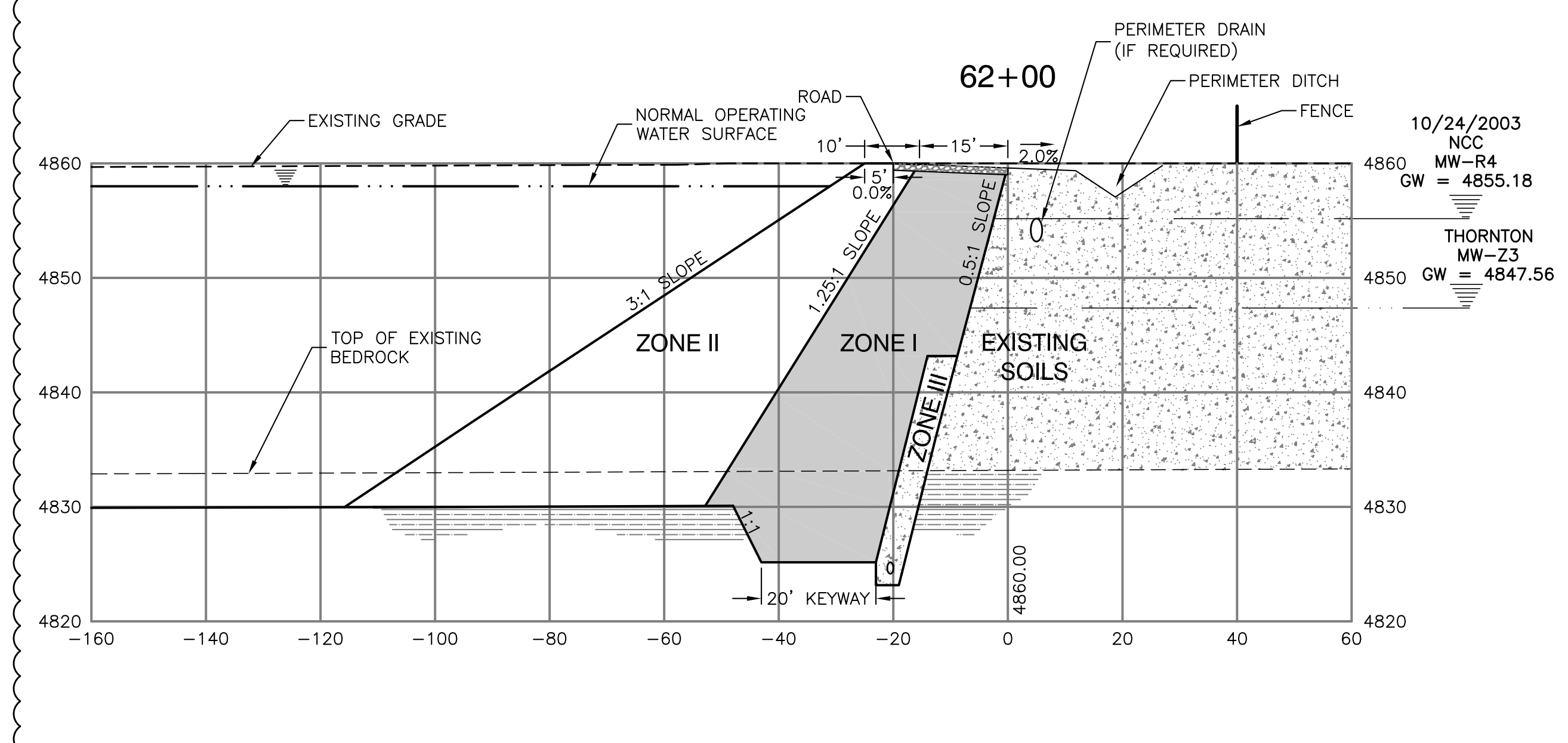
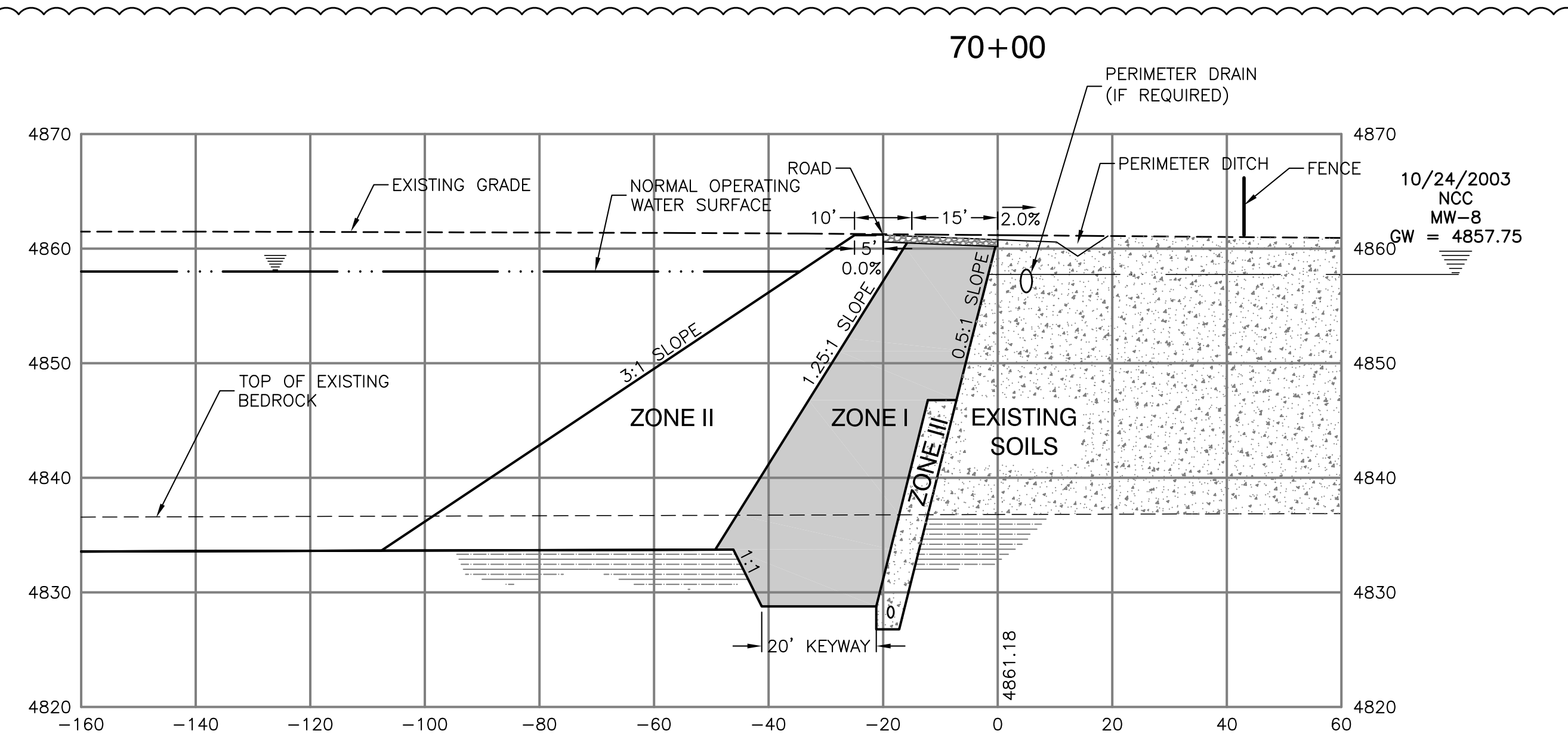
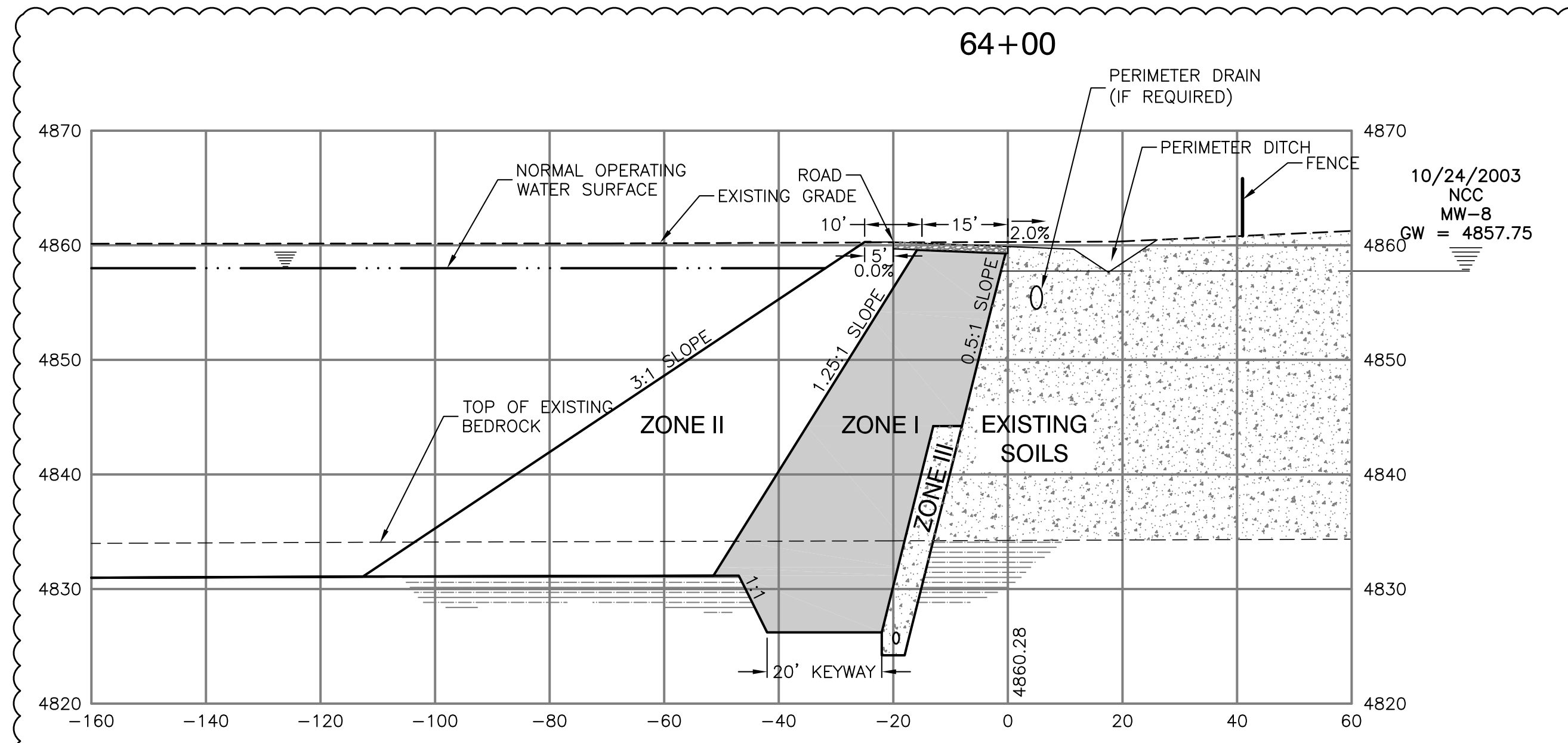

J&T Consulting, Inc.
305 Denver Avenue - Suite D
Fort Lupton, CO 80621
Ph: 303-857-6222 Fax: 303-857-6224
www.jtconsulting.com

Reservoir Liner Construction Plans
South Cell
Cross - Sections
Sta: 58+00 to 70+00

Northern Colorado Constructors, Inc.
NCC Pit #1

ISSUED FOR CONSTRUCTION

No	Date	By	Chk	Description
1	9/30/08	WSS	JCY	Issued For Construction
2	9/25/19	WSS	JCY	City of Thornton Comments
3	9/25/19	WSS	JCY	City of Thornton Comments
4	10/31/19	TWT	JCY	City of Thornton Comments
5	1/17/20	WSS	JCY	City of Thornton Comments
6	3/25/20	BOC	JCY	City of Thornton Comments
7	5/27/20	TPY	JCY	City of Thornton Comments
8	11/9/20	TPY	JCY	Revised Perimeter Drain Layout

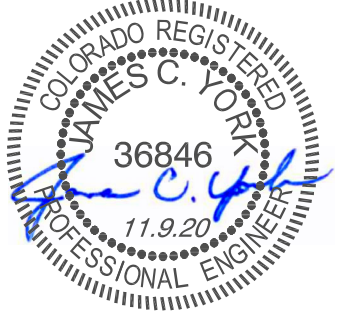

Job # 07121
Date 4/24/08
Drawn By TPY/WSS
Designed By TPY
Checked By JCY
File JT-Xsecs
Scale 1" = 20'h/10'v

Sheet: 16 of 20

P:\07121 NCC Liner Design\Drawings\CD\NCC 2020 updated set - no north reservoir\JT-Xsecs.dwg, 16 Cross - Sections, 10/10/2023 1:54:12 PM

NOTE:
LIMITS OF EXCAVATION SHOWN ARE APPROXIMATE. EXCAVATE TO LIMITS DETERMINED IN THE FIELD BY ENGINEER.

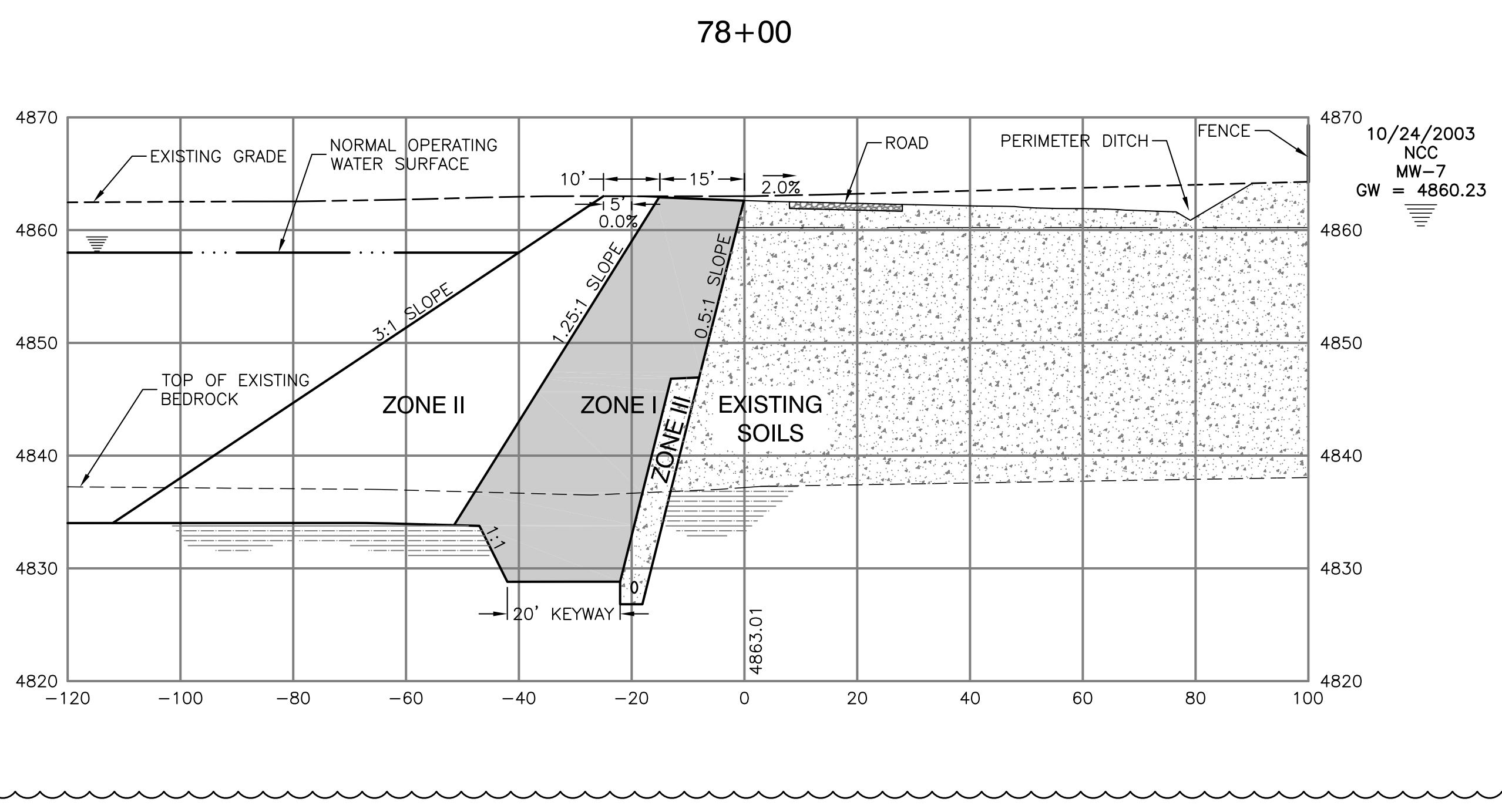
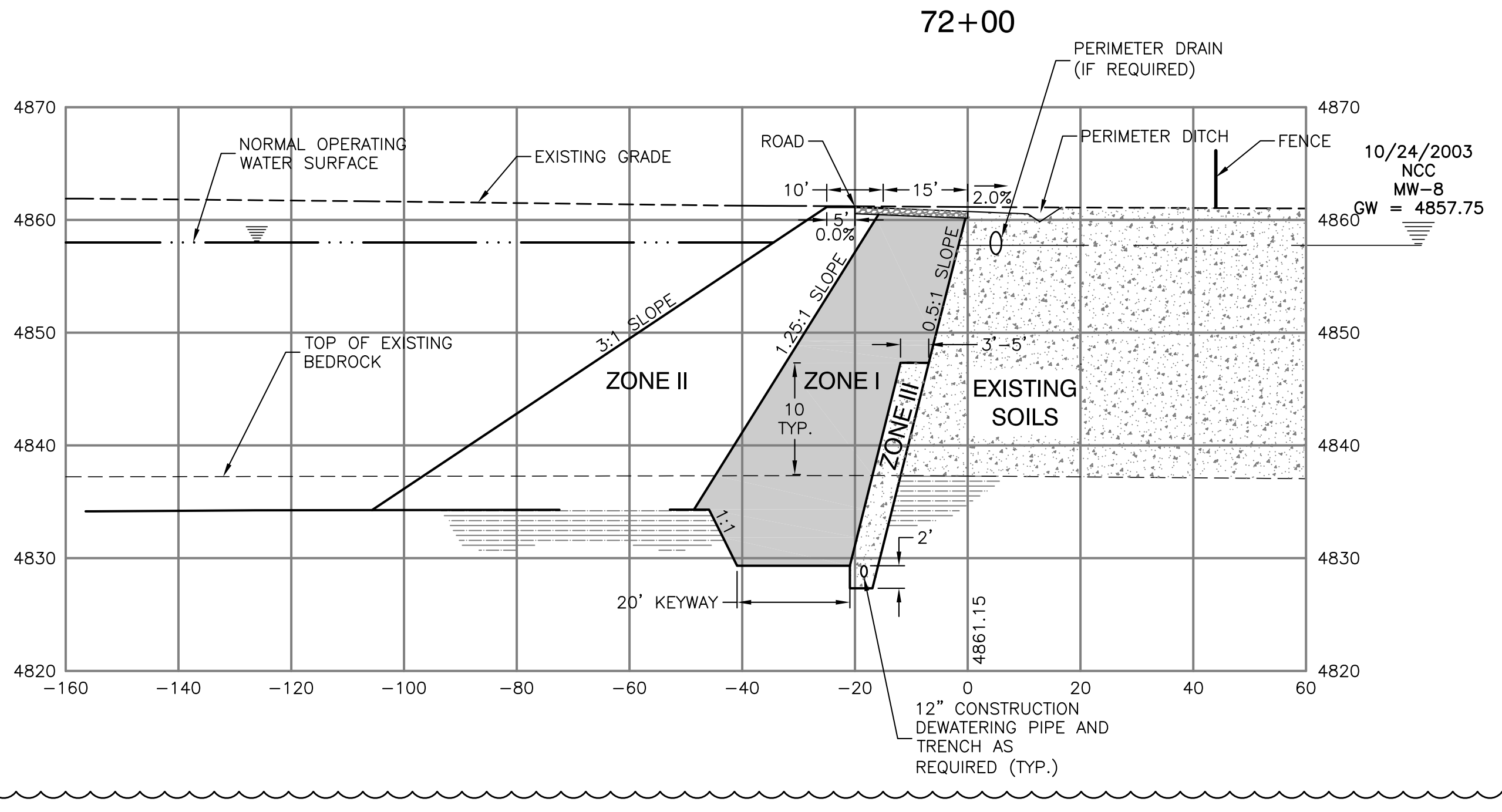
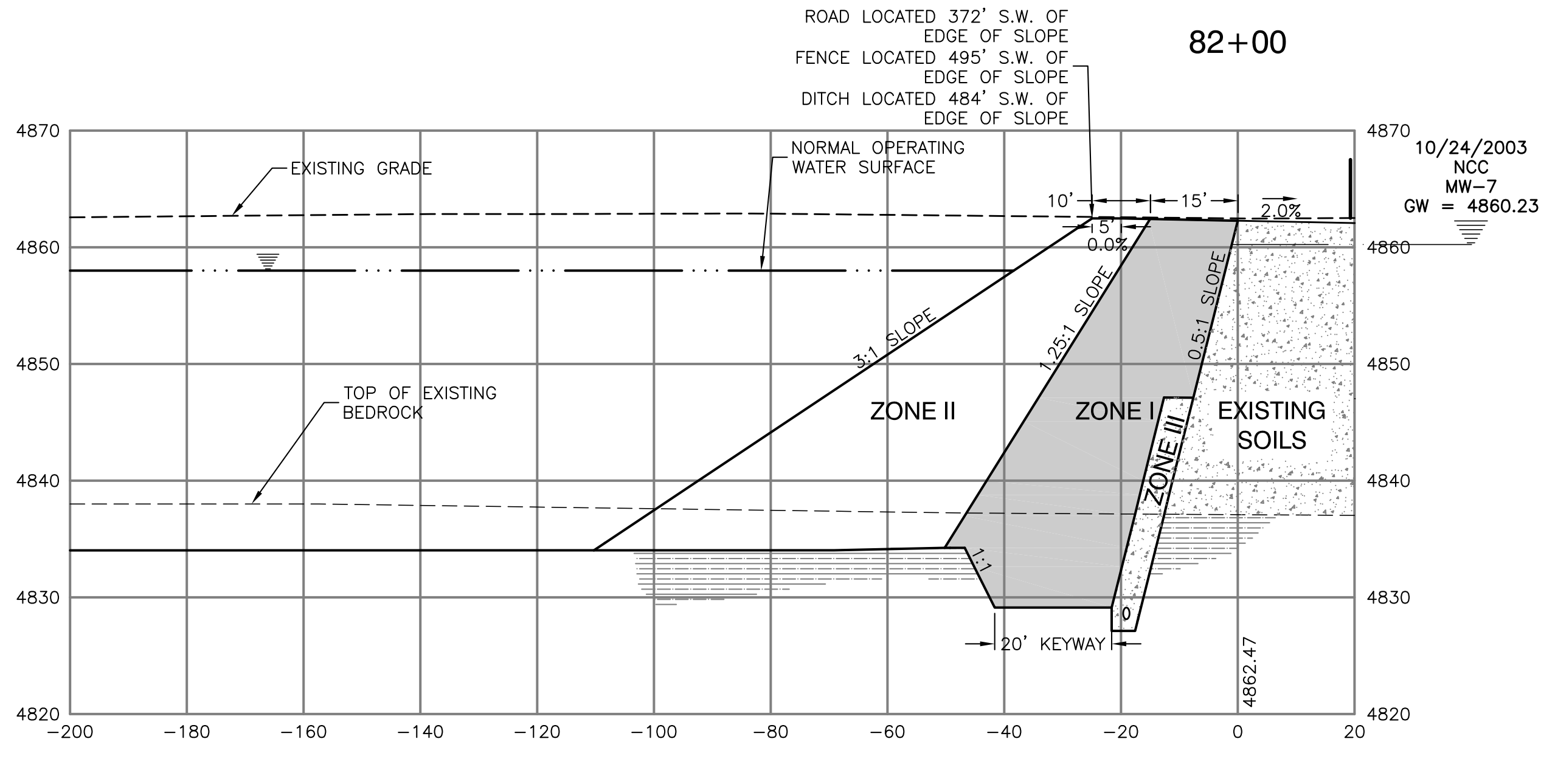
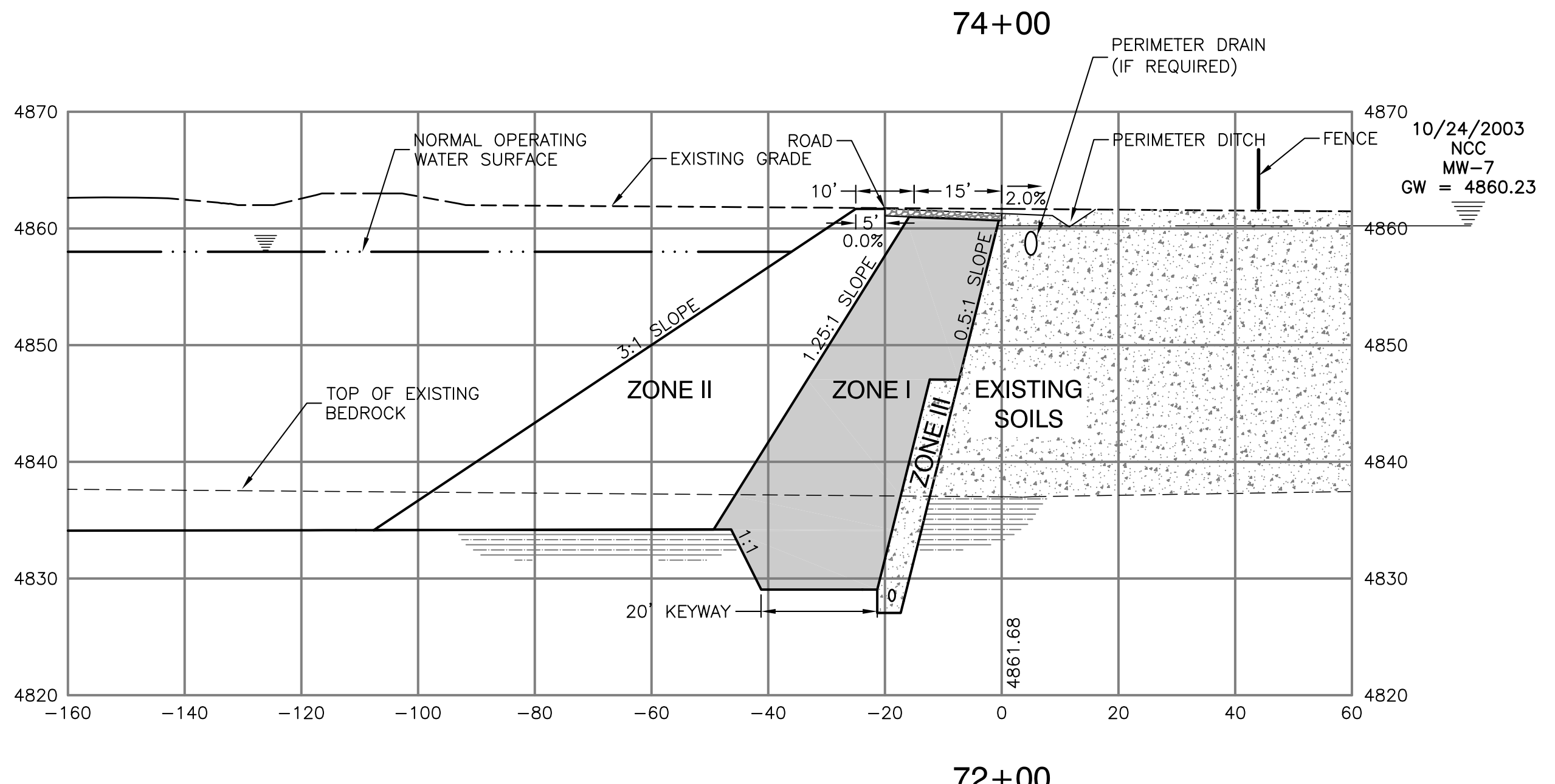
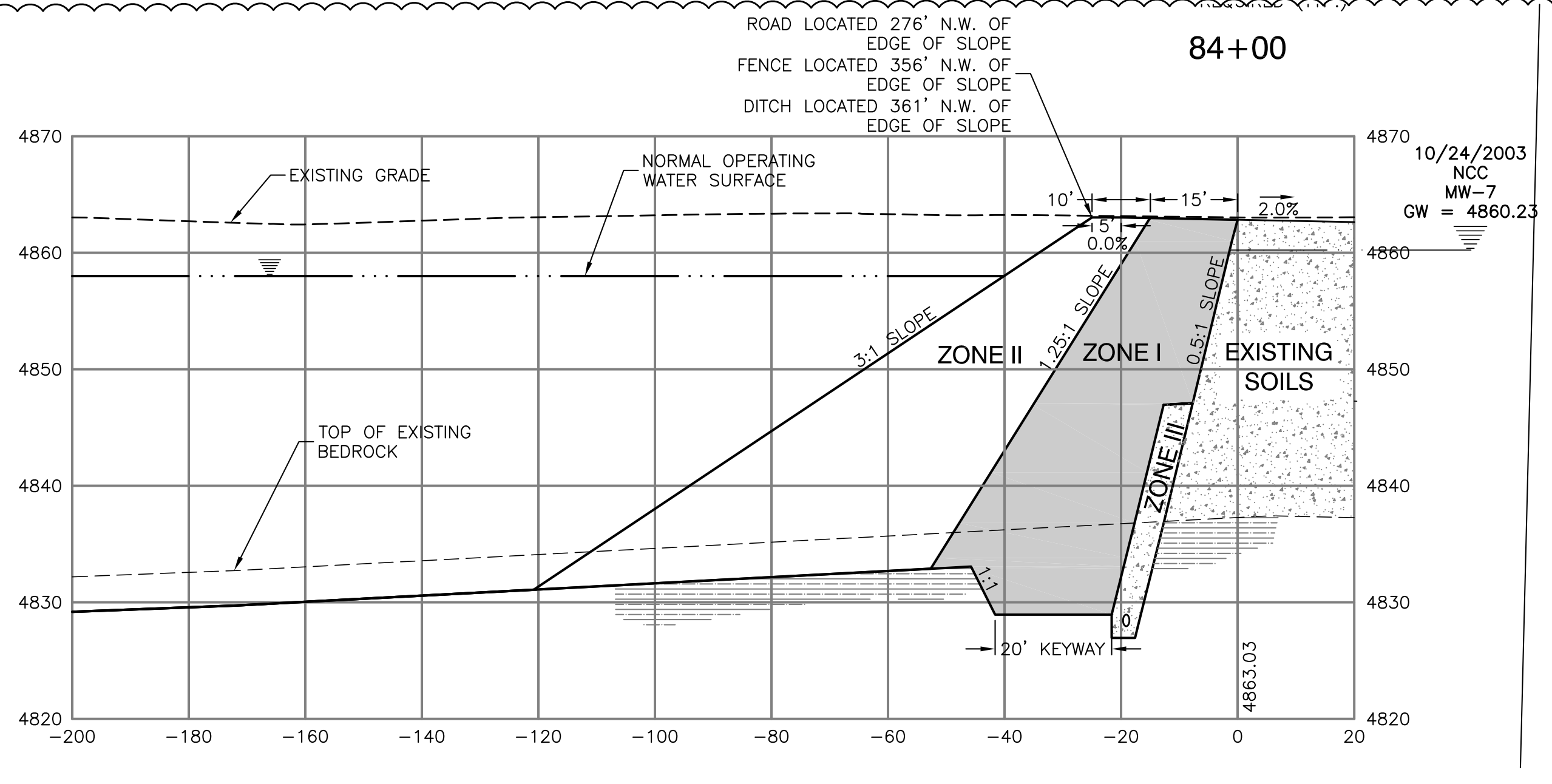
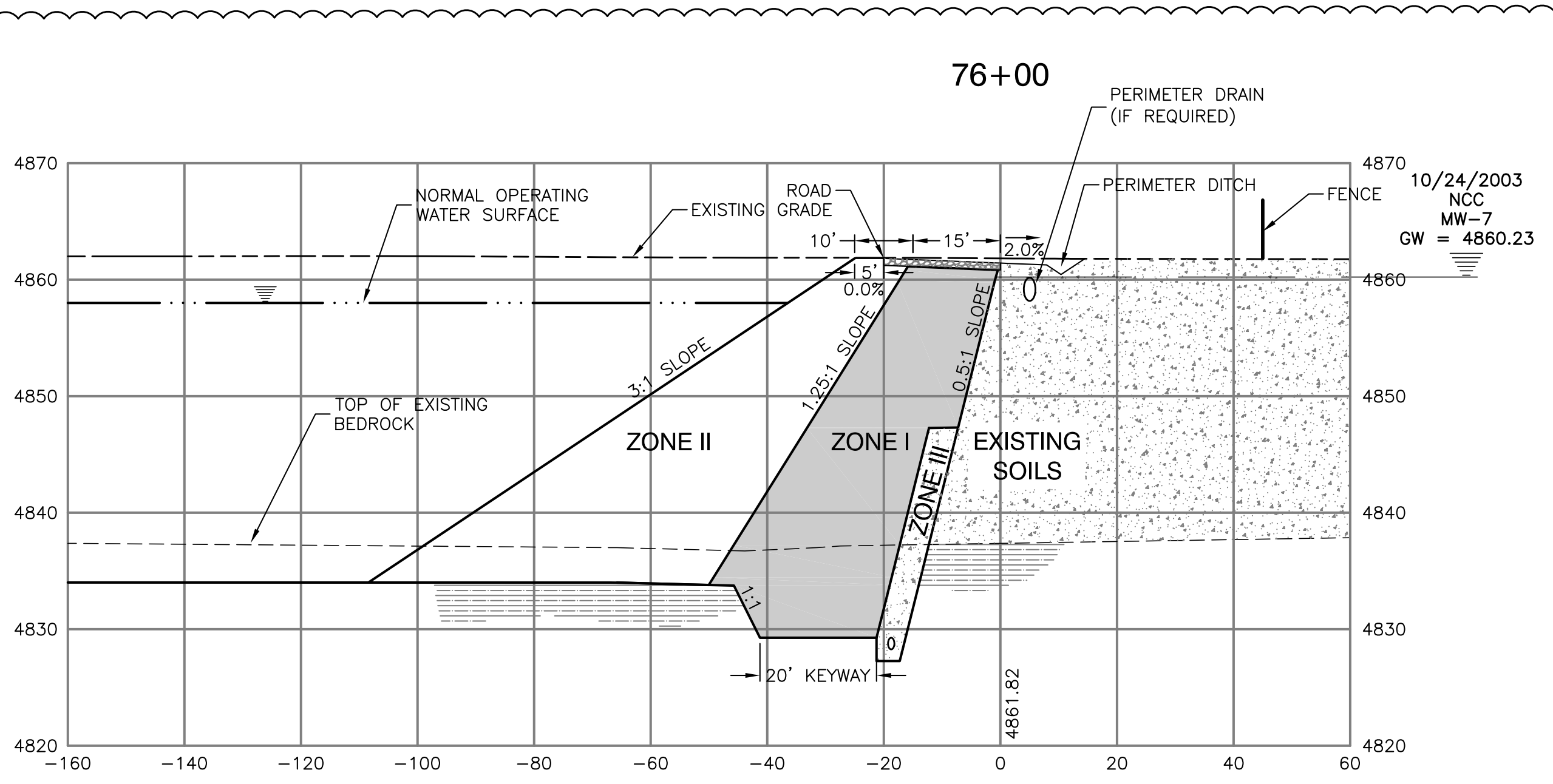

J&T Consulting, Inc.
305 Denver Avenue - Suite D
Fort Lupton, CO 80621
Ph: 303-857-6222 Fax: 303-857-6224
www.jtconsulting.com

Reservoir Liner Construction Plans
South Cell
Cross - Sections
Sta: 72+00 to 84+00

Northern Colorado Constructors, Inc.
NCC Pit #1

REVISIONS

No	Date	By	Chk	Description
1	9/30/09	WSS	JCY	Issued For Construction
2	9/25/19	WSS	JCY	City of Thornton Comments
3	10/17/19	WSS	JCY	City of Thornton Comments
4	10/17/19	TWT	JCY	City of Thornton Comments
5	1/17/20	WSS	JCY	City of Thornton Comments
6	3/25/20	BDC	JCY	City of Thornton Comments
7	5/27/20	TPY	JCY	City of Thornton Comments
8	11/9/20	TPY	JCY	Revised Perimeter Drain Layout

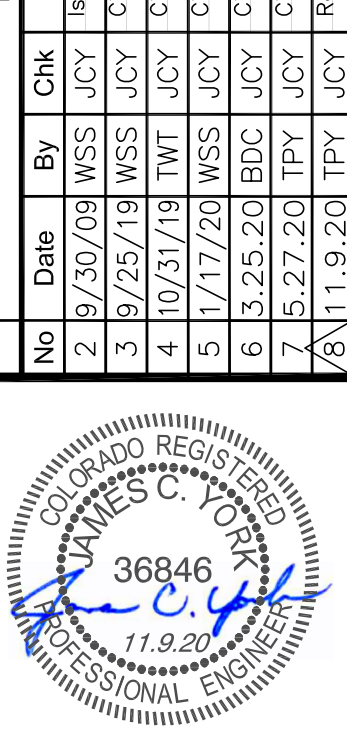

Job # 07121
Date 4/24/08
Drawn By TPY/WSS
Designed By TPY
Checked By JCY
File JT-Xsecs
Scale 1" = 20'h/10'v
Sheet: 17 of 20

ISSUED FOR CONSTRUCTION

P:\07121 NCC Liner Design\Drawings\CD\NCC 2020 updated set - no north reservoir\JT-Xsecs.dwg, 17 Cross - Sections, 10/24/2003 12:09 PM

NOTE:

LIMITS OF EXCAVATION SHOWN ARE APPROXIMATE. EXCAVATE TO LIMITS DETERMINED IN THE FIELD BY ENGINEER.

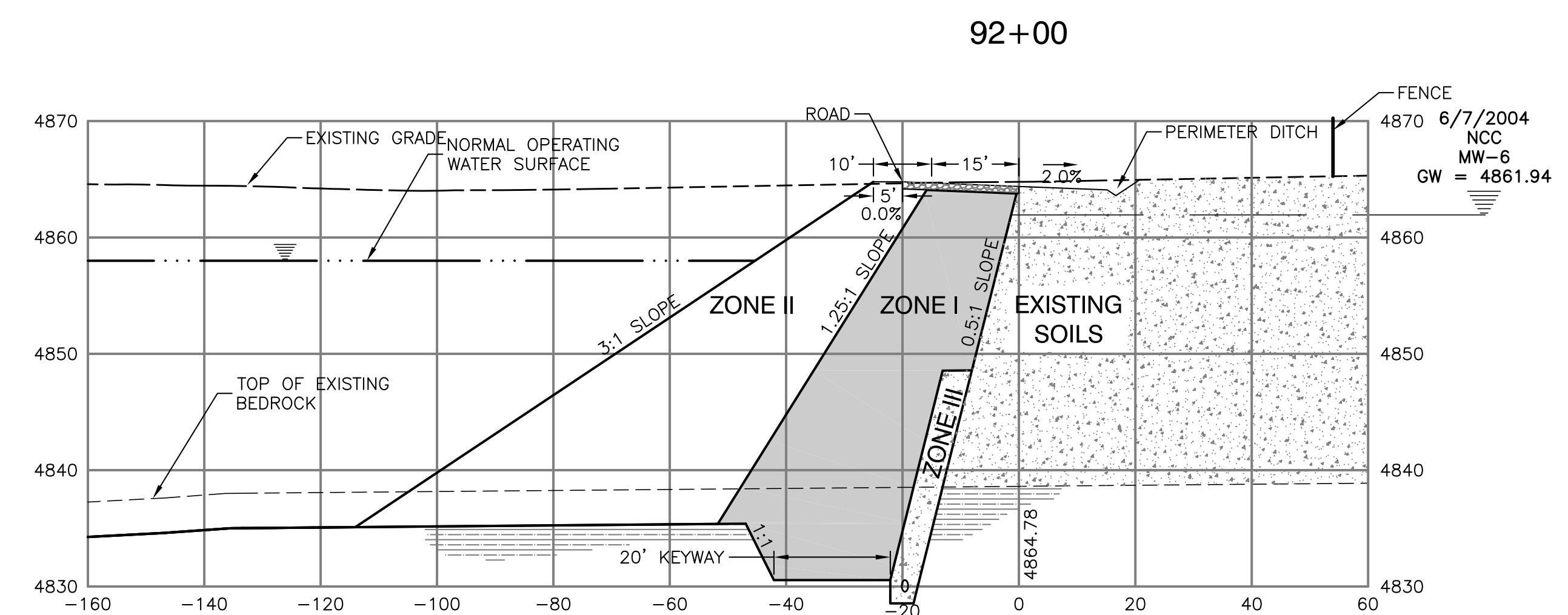
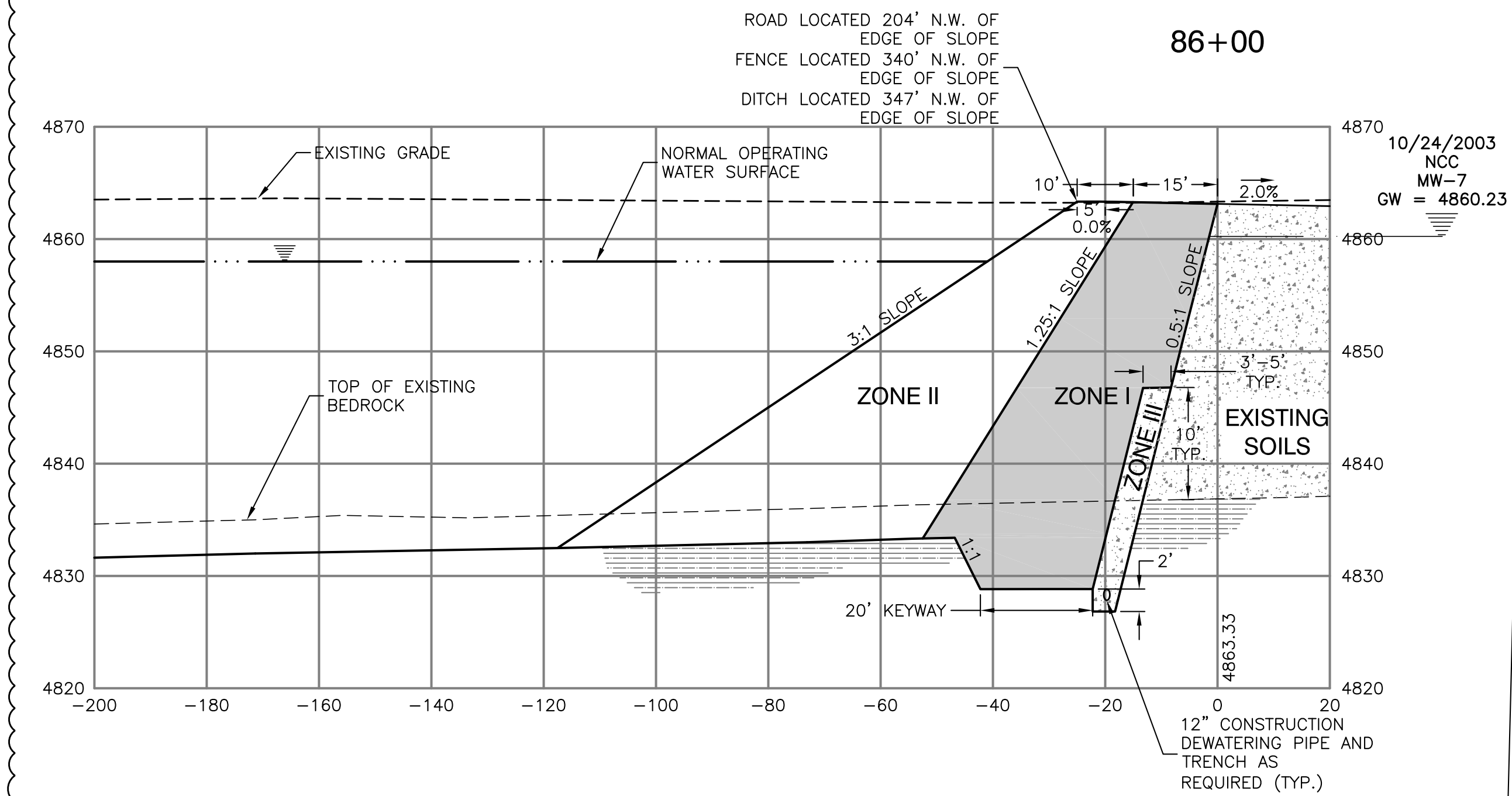
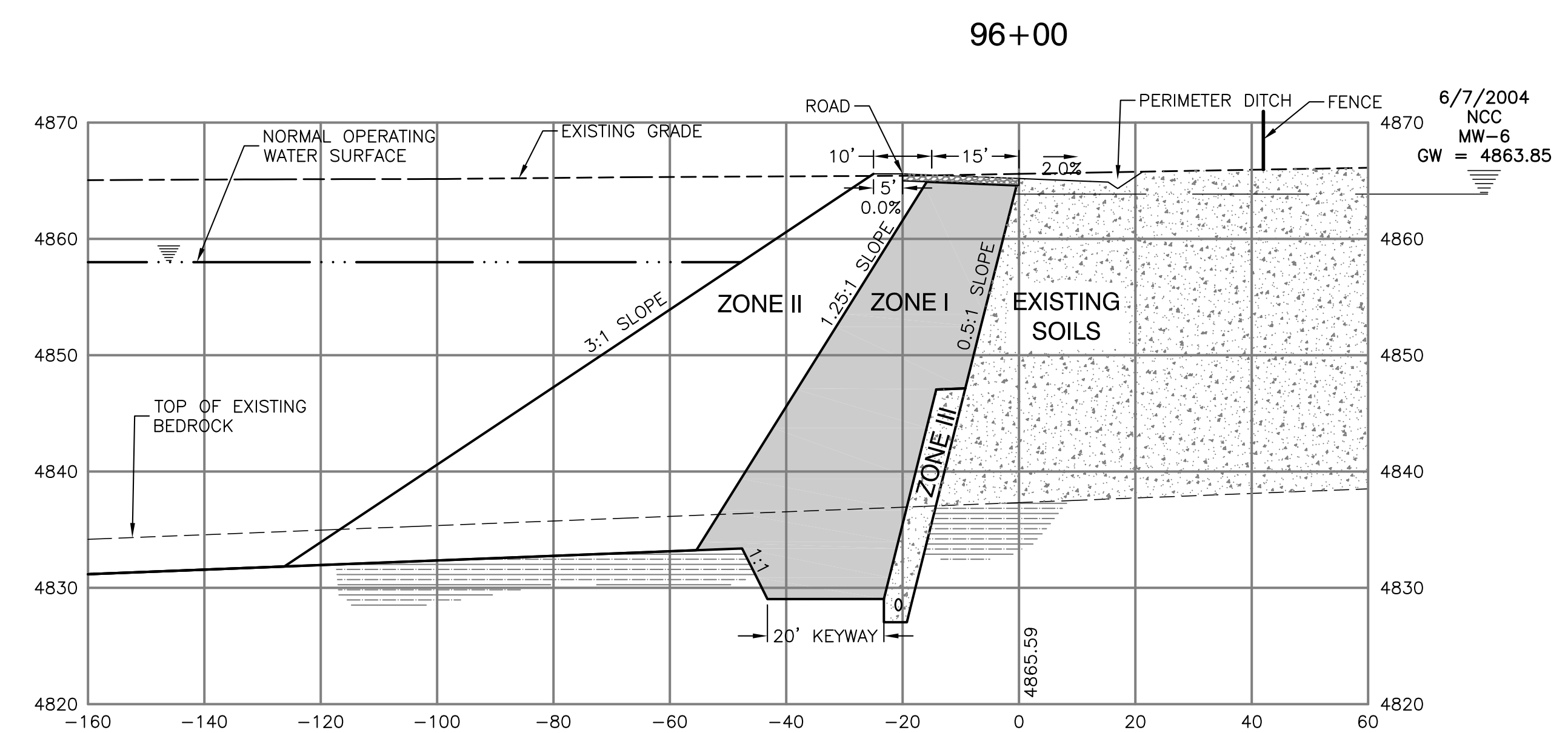
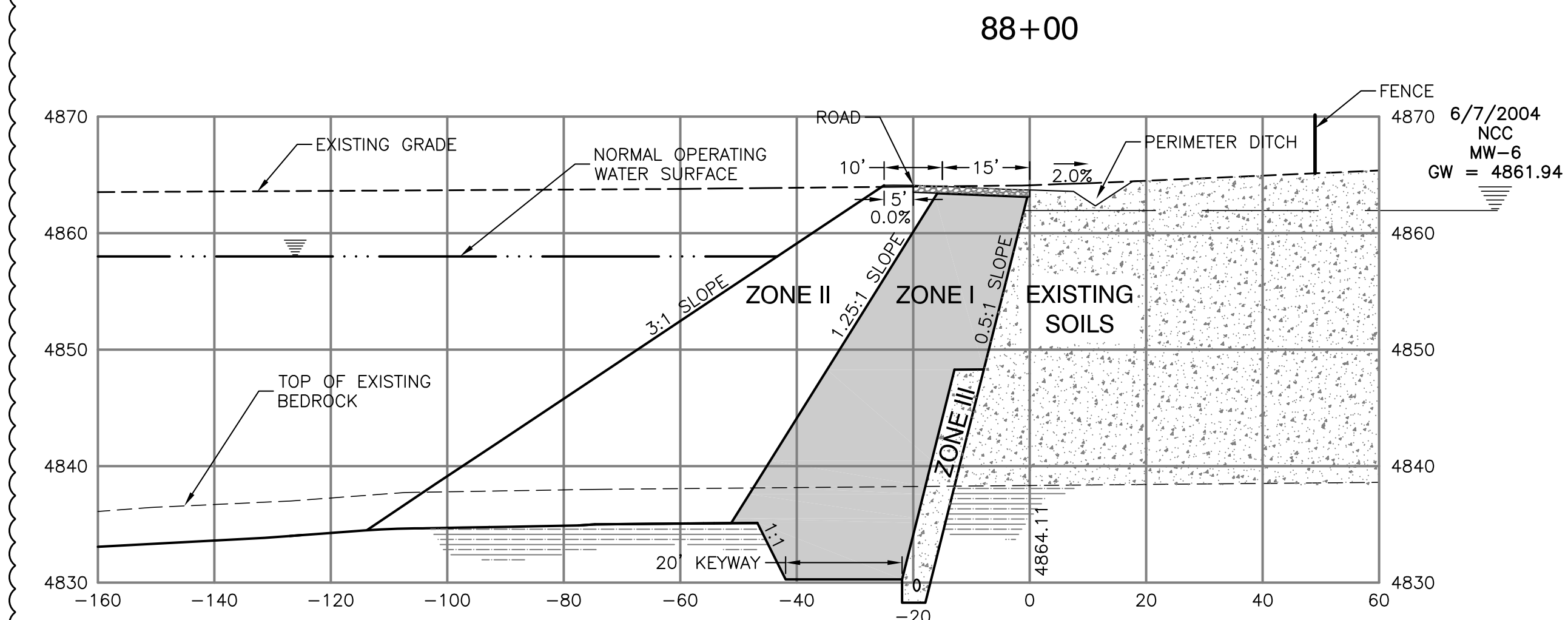
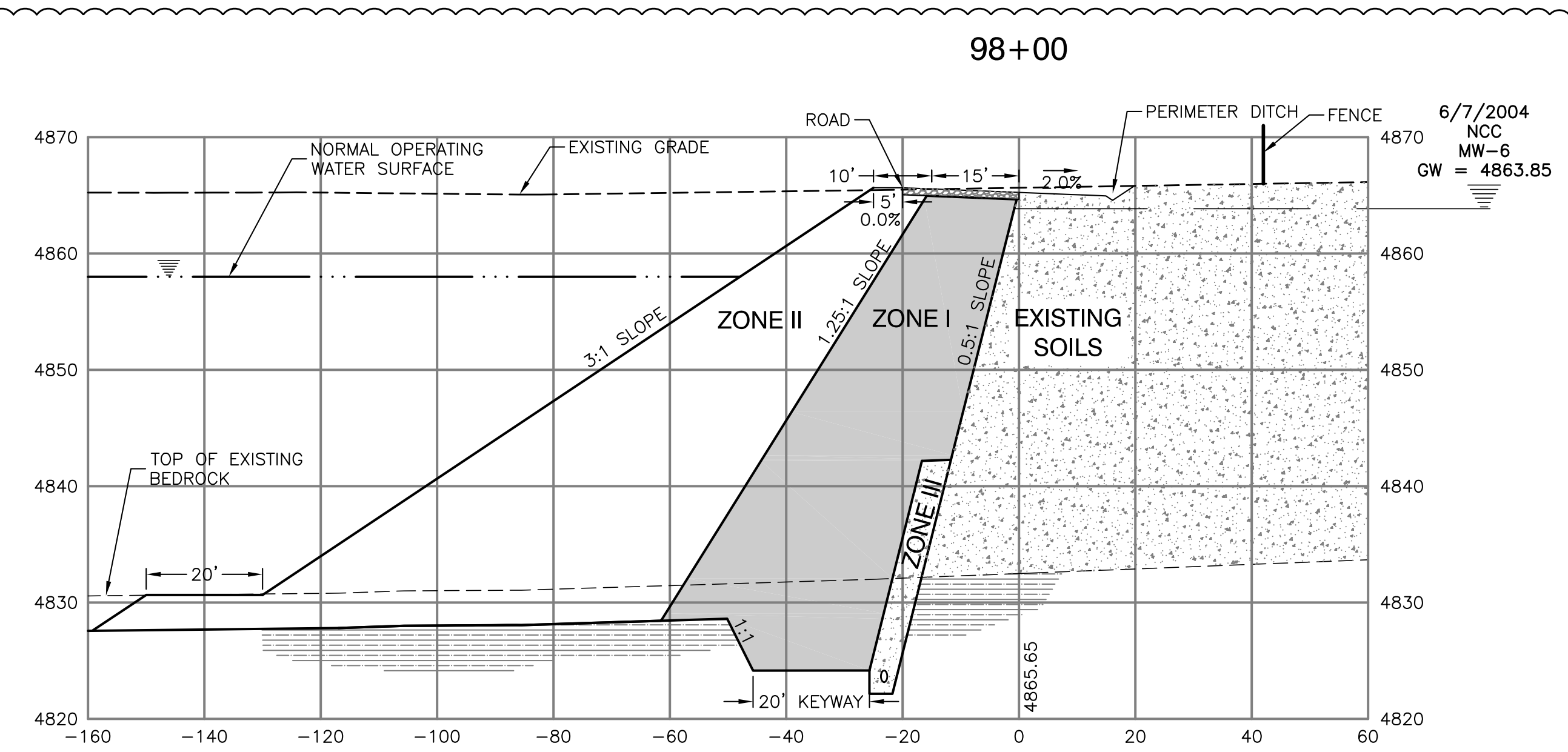
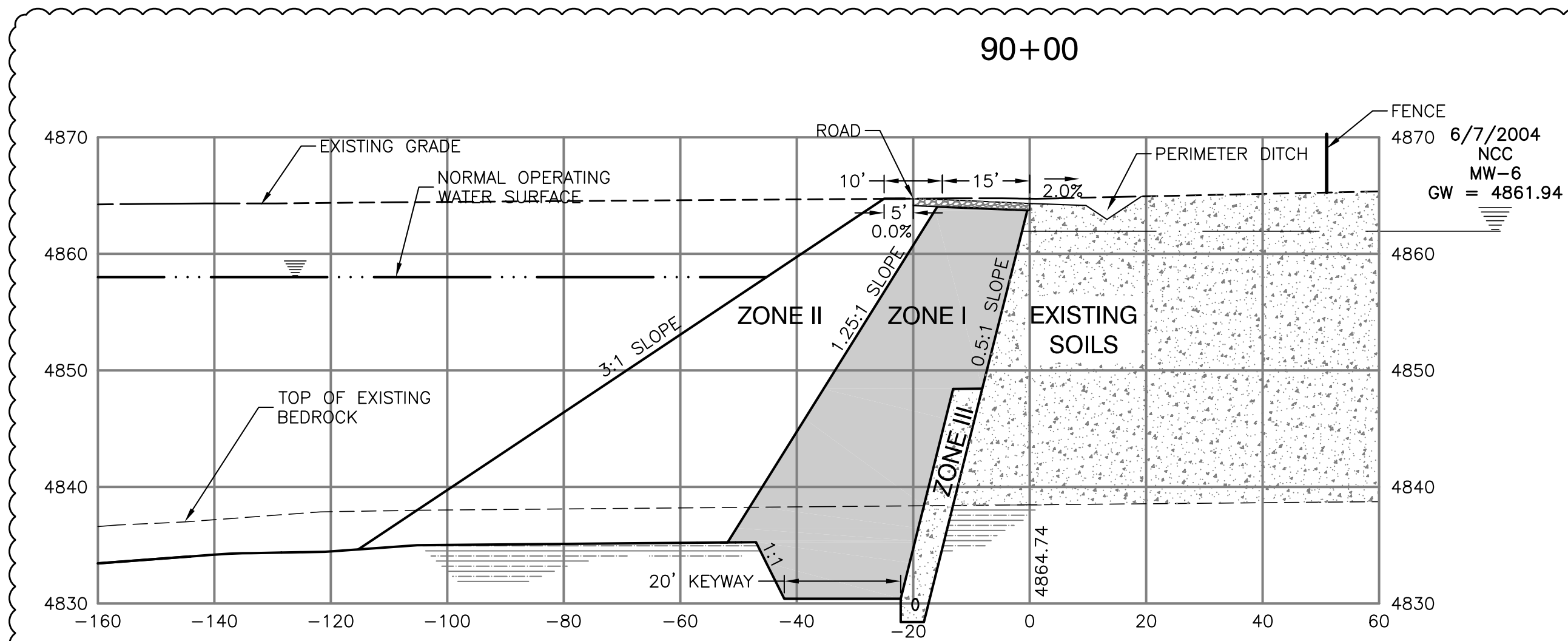

8

REVISIONS

No	Date	By	Chk	Description
1	2/9/09	WSS	JCY	Issued For Construction
2	9/25/19	WSS	JCY	City of Thornton Comments
3	9/25/19	WSS	JCY	City of Thornton Comments
4	10/31/19	TWT	JCY	City of Thornton Comments
5	1/17/20	WSS	JCY	City of Thornton Comments
6	3/25/20	BDC	JCY	City of Thornton Comments
7	5/27/20	TPY	JCY	City of Thornton Comments
8	11/9/20	TPY	JCY	Revised Perimeter Drain Layout

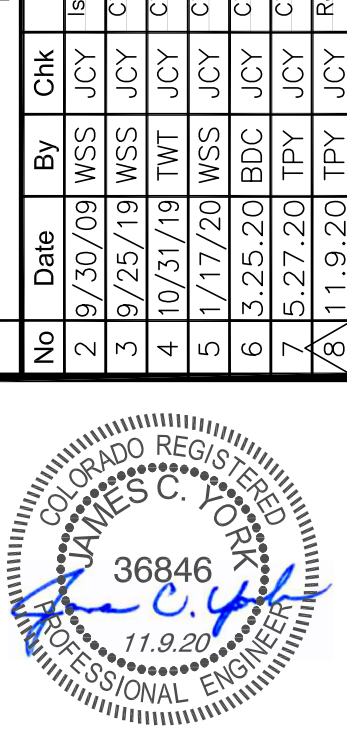

Job #	07121
Date	4/24/08
Drawn By	TPY/WSS
Designed By	TPY
Checked By	JCY
File	JT-Xsecs
Scale	1" = 20'h/10'v

ISSUED FOR CONSTRUCTION

P:\07121\NCC\Liner Design\Drawings\CD\NCC 2020 updated set - no north reservoir\JT-Xsecs.dwg, 18 Cross - Sections, 10/14/2023, 12:40 PM

THIS PAGE INTENTIONALLY LEFT BLANK

EXHIBIT D

SCHEDULE OF CONTRACT PAY ITEMS AND PRICES

**City of Thornton
Zadel Reservoir Fencing, Project No. 18-554**

Item No.	Description	Unit	Quantity	Price	Total Price
1	Mobilization	LS	1		
2	7-foot Chain Link Fence	LF	9,635		
3	24-foot Double Gate	EA	1		
				GRAND TOTAL	

THIS PAGE INTENTIONALLY LEFT BLANK

THIS PAGE INTENTIONALLY LEFT BLANK

EXHIBIT F

**PERFORMANCE BOND & LABOR AND
MATERIAL PAYMENT BOND**

**City of Thornton
Zadel Reservoir Fencing, Project No. 18-554**

THIS PAGE INTENTIONALLY LEFT BLANK

PERFORMANCE BOND

The **City of Thornton**, a home rule municipality, located at 9500 Civic Center Drive, Thornton, Colorado 80229 ("Thornton" or "Obligee") and **CONTRACTOR** ("Contractor"), having an office at **CONTRACTOR'S ADDRESS** have entered into Contract with a Notice of Award dated _____, 20__ for Construction in connection with Zadel Reservoir Fencing, Project No. 18-554 (the "Project").

By virtue of this Bond, Contractor Principal, and **SURETY'S NAME** having an office at **SURETY'S ADDRESS** (the "Surety") are firmly bound to Thornton, for the maximum amount of \$ [spell out dollar amount here] Dollars [XXXXXXXX] (the "Bond Sum").

Contractor and Surety bind themselves, their heirs, executors, administrators, successors and assigns, jointly and severally, to Obligee for the performance of the Work this Project requires.

I. BOND TERMS

- A. The Contract by this reference is incorporated into this Performance Bond.
- B. If Contractor performs its Contract obligations (the "Work") as required, Surety shall have no further obligations under this Bond. If Contractor does not perform the Work, Surety's obligations under this Bond shall remain in full force and effect.
- C. Surety waives notice of any change made by Thornton, including changes of time, to the Contract or to related subcontracts, purchase orders and other obligations.
- D. If Contractor is in default on the Contract, and Thornton has performed its obligations under the Contract, Surety shall promptly and at the Surety's expense take one (1) of the following actions:
 1. Surety may promptly remedy the default;
 2. Surety shall promptly;
 - a. With Thornton's consent, complete the Contract in accordance with its terms and conditions using its agents or independent contractors;
 - b. Obtain one or more bids from lowest, qualified contractors acceptable to Thornton to complete the Contract in accordance with its terms and conditions;
 - c. Arrange for a contractor, acceptable to Thornton, to complete the Work in accordance with its terms and conditions of the Contract and secured by performance and payment bonds issued by a qualified surety. Surety will ensure sufficient funds are available to pay the cost to complete the Work as it progresses, and other costs and damages Surety may be liable to pay, minus the balance of the Contract price,

up to Bond Sum indicated in the first paragraph of this Performance Bond. The term "balance of the Contract" as used in this subsection c, means the total amount payable by Thornton to Contractor under the Contract and any Contract Change Orders thereto, less the amount properly paid by Thornton to Contractor.

II. ADDITIONAL TERMS

- A. **Duration.** This obligation will run continuously, and will remain in full force and effect until and unless the Bond is terminated and cancelled as provided in the Contract or as otherwise provided by law.
- B. **Bond Venue.**
 - 2. The venue for any action, dispute or proceeding initiated in connection with this Bond will be District Court in and for the County of Adams, State of Colorado.
 - 3. Any suit under this Bond must be instituted before the expiration of two (2) years from the date on which final payment under the Contract falls due.
- C. **No Other Beneficiaries.** No right of action shall accrue on this Bond to or for the use of any person or corporation other than Thornton.
- D. **Severability.** If one or more of the provisions of this Bond are determined to be illegal or unenforceable by a court of competent jurisdiction, all other provisions will remain effective.

Signed and sealed this _____ day of _____, 20_____.

Witness

Principal

Title

Title

Witness

Surety

Title

Title

LABOR AND MATERIAL PAYMENT BOND

The **City of Thornton**, a home rule municipality, located at 9500 Civic Center Drive, Thornton, Colorado 80229 (“Thornton” or “Obligee”) and **CONTRACTOR** (“Contractor”), having an office at **CONTRACTOR’S ADDRESS** have entered into Contract with a Notice of Award dated _____, 20__ for Construction in connection with Zadel Reservoir Fencing, Project No. 18-554 (the “Project”).

By virtue of this Bond, Contractor as Principal, and **SURETY’S NAME** having an office at **SURETY’S ADDRESS** (the “Surety”) as the Principal and Surety are firmly bound to Thornton, for the benefit of Claimants, in the amount of \$**[spell out dollar amount here]** Dollars (**\$XXXXXXXX**). Claimants means, without limitation, an individual or entity contracting directly with Contractor or with a subcontractor of Contractor to furnish labor and materials for use in the performance of the Contract, and also includes any individual or entity that has rightfully asserted a claim under an applicable mechanic’s lien or state statute against Contractor for the Project.

Contractor and Surety bind themselves, their heirs, executors, administrators, successors and assigns, jointly and severally, to pay for labor, materials and equipment furnished by Claimants for the performance of the Contract for the specified Work and set forth in the Drawings and Specifications.

I. BOND TERMS

- A. The Contract by this reference is incorporated into this Labor and Material Payment Bond.
- B. Surety waives notice of any change made by Thornton, including changes of time, to the Contract or to related subcontracts, purchase orders and other obligations.
- C. If the Contractor promptly makes payment of all sums due to Claimants, and defends, indemnifies and holds Thornton harmless for claims, demands, liens or suits by any person or entity seeking payment for labor, materials or equipment furnished for use in the performance of the Construction Contract, Surety shall have no further obligations under this Bond. If Contractor fails to promptly make payment of all sums due to Claimants, Contractor’s and Surety’s obligations under this Bond shall remain in full force and effect, and be subject to the following:
 - 1. Claimants that directly contract with Principal, or with a subcontractor of the Principal, for labor and materials or a combination of both used or reasonably required for use in the performance of the Contract. Labor and materials include without limitation all and any part of water, gas, power, light, heat, oil, gasoline, equipment, telephone service or rental equipment used in the Contract, and, if applicable, architectural and engineering services required for performance of the Work by Contractor and its subcontractors, and all other items that may be subject to filing a claim under this Bond.

2. The above-named Principal and Surety hereby jointly and severally agree that every claimant, who has not been paid in full before the expiration of ninety (90) Calendar Days after the date on which the last Claimant's Work or labor was done or performed, or furnished materials, may sue on this Bond, prosecute the suit to final judgment, and execute it to recover any and all sums justly due to Claimant. Thornton shall not be liable for the payment of any costs or expenses of any such suit.
3. No suit or action shall be commenced by any Claimant:
 - a. Until Claimant, other than a Claimant that directly contracts with the Principal, has given written notice to Principal, Thornton, and Surety, within ninety (90) Calendar Days after Claimant last performed Work or labor, or furnished materials. The notice for which the claim is made, must state with substantial accuracy the amount claimed, and the name of the party to whom the materials were furnished, or for whom the labor was performed. Notice shall be delivered by registered mail or certified mail, postage prepaid, in an envelope addressed to the Principal, Thornton and Surety, at the place where an office is regularly maintained for the transaction of business, or it may be served in any manner by which legal process is served in the state where the Project is located, however, service need not be made by a public officer;
 - b. After the expiration of six (6) months from the date Principal stopped performing the Work pursuant to the Contract. It is understood that if any time limitation embodied in this Bond is prohibited by law controlling such limitation, this Bond shall be deemed amended to equal the minimum period of time limitation as such law permits;
 - c. Other than in a state court of competent jurisdiction in, and for the county or other political subdivision of the state where the Project, or any part of it is situated, or in the United States District Court of the District where the Project, or any part it is situated, and no other place.

Signed and sealed this _____ day of _____ 20__.

Witness

Principal

Title

Title

Witness

Surety

Title

Title

THIS PAGE INTENTIONALLY LEFT BLANK

EXHIBIT G

INSURANCE REQUIREMENTS AND CERTIFICATE

City of Thornton Zadel Reservoir Fencing, Project No. 18-554

A. The Contractor agrees to procure and maintain in force during the term of this Contract, at its own cost, the following coverages:

1. Workers' Compensation Insurance. Workers' Compensation Insurance as required by the Labor Code of the State of Colorado and Employer's Liability Insurance. Evidence of qualified self-insured status may be substituted.

2.	<u>Commercial General Liability Insurance</u>	(MINIMUM LIMITS)
a.	Each Occurrence	\$2,000,000.00
b.	Products/Completed Operations Aggregate	\$2,000,000.00
c.	Personal and Advertising Injury	\$2,000,000.00
d.	General Aggregate	\$5,000,000.00

The policy shall include coverage protecting against bodily injury, property damage, and personal injury claims arising from the exposures of (1) premises-operations; (2) products and completed operations including materials designed, furnished and/or modified in any way by Contractor; (3) independent subcontractors; (4) contractual liability risk covering the indemnity obligations set forth in this Contract; and (5) where applicable, liability resulting from explosion, collapse, or underground exposures.

If the above insurance is written on a claims-made form, it shall continue for three (3) years following termination or completion of the Contract. The insurance shall provide for a retroactive date of placement prior to or coinciding with the effective date of the Contract.

3. Automobile Liability Insurance. Automobile Liability Insurance with minimum combined single limits for bodily injury and property damage of not less than one million dollars (\$1,000,000) for any one (1) occurrence. This insurance will insure against bodily injury and/or property damage arising out of the Contractor's operation, maintenance, use, loading or unloading of any auto including owned, non-owned, hired and employee autos.

4. Products and Completed Operations Liability Insurance. The Contractor shall provide Products and Completed Operations Liability Insurance and name Thornton as an additional insured for a minimum of one (1) year after the date of Final Acceptance. The Contractor shall continue to provide evidence of such coverage by submission of a Certificate of Insurance to Thornton no later than thirty (30) Calendar Days prior to the scheduled expiration of such coverage. Additional Insured endorsements shall indicate applicable Products and Completed Operations coverage.
- B. **Additional Insured.** The Contractor shall name Thornton, its officer, agents, and employees as additional insureds with respect to the Commercial General Liability and Auto Liability coverages above. Contractor shall require any Subcontractor to name Thornton, its officers, agents, and employees as additional insured with respect to Commercial General Liability and Auto Liability coverages.
- C. **Certificates of Insurance.**
1. A Certificate of Insurance shall be completed and forwarded, along with the Additional Insured Endorsements, to Thornton by the Contractor's Insurance Agent(s) as evidence that policies providing the required coverages, conditions, and minimum limits are in full force and effect and shall be subject to review and approval by Thornton **prior to commencement of any Work under this Contract.** The Contractor shall provide (or cause to be provided) copies of Certificates of Insurance from all subcontractors indicating the City's Additional Insured statuses on their General Liability and Auto Liability policies. The initial completed Certificate(s) of Insurance and Additional Insured Endorsement(s) shall include the Contractor's e-mail address for future inquiries and updates, and shall be sent to:

City of Thornton
Patrick Hinterberger, Contracts Supervisor
9500 Civic Center Drive
Thornton, CO 80229-4326
 2. Subsequent Certificates of Insurance indicating renewal of coverage(s) shall be sent to Thornton's Risk Manager at certificatesofinsurance@ThorntonCO.gov no later than thirty (30) Calendar Days prior to the expiration date. Indicate "Renewal COI" and the Project Number in the e-mail subject line.
 3. Thornton reserves the right to request and receive a certified copy of any policy and any endorsement thereto. Contractor agrees to execute any and all documents necessary to allow Thornton access to any and all insurance policies and endorsements pertaining to the Work

D. **Subcontractor Insurance Coverages.**

1. Contractor shall cause any Subcontractor to procure and maintain adequate levels of insurance coverage for Workers' Compensation, Commercial General Liability, Automobile Liability, and other coverages Contractor may require. Contractor shall require Professional Liability insurance for any Subcontractor performing delegated design services with minimum limits of \$1,000,000 per claim and \$2,000,000 aggregate, and if coverage is written on claims-made coverage form, it shall continue for three (3) years following termination of this agreement.
2. For Commercial General Liability and Automobile Liability insurance of any subcontractor, Thornton will be named as an additional insured. Contractor shall prepare a schedule of required coverages for each of its Subcontractors and shall submit such schedule to Thornton prior to any Subcontractor commencing any Work under the Contract. Such coverages for any Subcontractors shall be procured and maintained with forms and insurers acceptable to Thornton. All coverages shall be continuously maintained to cover all liability, claims, demands, and other obligations assumed by the Contractor.
3. Contractor shall require any Subcontractor to name Thornton, its officers, agents, and employees as additional insured with respect to Commercial General Liability and Auto Liability coverages.

E. **Other Insurance Requirements.**

1. Minimum Insurance Coverages. Contractor shall procure and maintain the minimum insurance coverages listed herein. Such coverages shall be procured and maintained with forms and insurers acceptable to Thornton. All coverages shall be continuously maintained to cover all liability, claims, demands, and other obligations assumed by the Contractor. If the above insurance is written on a claims-made form, it shall continue for three (3) years following termination or completion of the Contract. The insurance shall provide for a retroactive date of placement prior to or coinciding with the effective date of the Contract.
2. Supplemental Insurance Coverage. Other insurance, with varying limits, which from time to time, may reasonably be required by the mutual agreement of Thornton and Contractor against other insurable hazards relating to the Work to be done, shall be provided.
3. Primary Insurance Coverage. Every policy required above shall be primary insurance, and any insurance carried by Thornton, its agents, officers, or employees shall be excess and not contributory insurance to that provided by the Contractor. The Contractor shall be solely responsible for any deductible losses under the required policies and such deductible losses shall not be billed to Thornton.

4. The Contractor shall not be relieved of any liability, claims, demands or other obligations assumed pursuant to the Contract by reason of its failure to procure and maintain insurance, or by reason of its failure to procure or maintain insurance in sufficient amounts, durations or types.
5. All policies shall include a provision that the coverages afforded under the policies shall not be canceled, terminated, or materially changed prior to the natural termination date until at least thirty (30) Calendar Days prior written notice has been sent to Thornton. The Certificate(s) shall indicate the form used, if any, under which this provision is included.

F. **Failure to Insure.** Failure on the part of the Contractor or a Subcontractor to procure or maintain policies providing the required coverages, terms, conditions, and minimum limits shall constitute a material breach of Contract upon which Thornton may immediately terminate the Contract. At its discretion, Thornton may procure or renew any such policy or any extended reporting period and may pay any and all premiums in connection therewith, and all monies paid by Thornton shall be repaid by Contractor to Thornton upon demand, or Thornton may offset the cost of the premiums against any monies due or to become due to Contractor from Thornton. In addition to the foregoing, in the event any coverage required by the Contract expires or is cancelled during the term of the Contract, the Contractor shall be required, without further notice from Thornton, to suspend the Work at 12:00 a.m. on the date of insurance expiration or cancellation, and may not resume Work until the required insurance coverage is obtained and evidence of such coverage is submitted to and approved in writing by Thornton. The Contractor shall not be entitled to any compensation therefor, including compensation for delay. The Contract Time shall continue to run during such suspension period and the Contractor shall remain fully responsible for any Liquidated Damages that are assessed as a result of late performance. During such suspension of Work the Contractor remains responsible for all safety and protection of persons and property under the Contract.

G. **Governmental Immunity.** The Parties understand and agree that Thornton, its agents, officers, and employees, are relying on, and do not waive or intend to waive by any provision of this Contract, the monetary limitations or any other rights, immunities, and protections provided by the Colorado Governmental Immunity Act, C.R.S. 24-10-101 et seq., as may be amended, or otherwise available to Thornton, its agents, officers, or employees.

CERTIFICATES OF INSURANCE

THIS PAGE INTENTIONALLY LEFT BLANK

EXHIBIT H

CHANGE ORDER FORM

Date:		Order No. 1					
Project Name: Zadel Reservoir Fencing		CC/CA: XX/XX CIP No. 18-554					
Contractor:							
Explanation:							
You are hereby requested to comply with the following changes to the Contract.							
Item No.	Description of Changes	Units	Unit Price	Added Quantity	Deleted Quantity	Total Decrease	Total Increase
1						\$ -	\$ -
2						\$ -	\$ -
3						\$ -	\$ -
4						\$ -	\$ -
5						\$ -	\$ -
6						\$ -	\$ -
7						\$ -	\$ -
8						\$ -	\$ -
9						\$ -	\$ -
10						\$ -	\$ -
11						\$ -	\$ -
12						\$ -	\$ -
13						\$ -	\$ -
14						\$ -	\$ -
15						\$ -	\$ -
16						\$ -	\$ -
17						\$ -	\$ -
18						\$ -	\$ -
19						\$ -	\$ -
20						\$ -	\$ -
21						\$ -	\$ -
SUBTOTALS, DECREASES AND INCREASES						\$ -	\$ -
NET CHANGE IN CONTRACT PRICE						\$0.00	

	Order No. 1
	CIP No. 18-554
The original Contract Sum (or GMP) was:	\$ -
Net Change of Previously Authorized Change Orders:	\$ -
Contract Sum Prior to this Change Order	\$ -
Value of this Change Order	\$ -
The New Contract Sum Including this Change Order	\$ -
The Contract total, including this and previous Change Orders, will be:	
	\$ -
<p>The Contract Time will [SELECT remain the same or be increased or be decreased by X Calendar Days.] The date for Substantial Completion of all Work is <date>.</p> <p>Acceptance of this Contract Change Order by the Contractor is a complete waiver and release by the Contractor, its Subcontractors and its suppliers of all direct, indirect, consequential, and impact-related costs resulting from or related to this Change, and its effect, if any, on unchanged Work, including, but not limited to delays, impacts, or disruption, as well as extended or increased jobsite and home office overhead costs that may be experienced or incurred as a result of performance of this Change within the Contract Time, as revised. This document will become a supplement to the Contract and all provisions will apply hereto.</p> <p>[EDIT Department Name] recommends acceptance of this Change Order:</p>	
XXXXX, Engineering Manager [revise as appropriate]	XXXXX, Senior Civil Engineer [revise as appropriate]
Accepted by: Contractor:	City of Thornton:
By: (Print name, title)	Kimberly Newhart, Finance Director
Kevin S. Woods, City Manager	Sean Saddler, PE, Contracts and Purchasing Director

Distribution: 2-Contractor, 1-CA file, 1-City Clerk

Page 2 of 2

EXHIBIT K

**SAMPLE NOTICE OF AWARD
& NOTICE TO PROCEED**

THIS PAGE INTENTIONALLY LEFT BLANK

NOTICE OF AWARD

Thornton, CO

Date

TO: [contractor name and address]

The City of Thornton, having duly considered the Bid Proposal submitted on [date], for Zadel Reservoir Fencing, Project No. 18-554 as detailed in the Contract Documents and it appearing that your Bid Proposal for performing the Work is fair, equitable and to its best interest, the said Bid Proposal is hereby accepted in the amount of xxxxxxxxxx (\$xxxxxxx).

In accordance with the terms of the Contract Documents, you are required to furnish the required Performance Bond and Labor and Material Payment Bond within ___ (XX) consecutive Calendar Days from and including the date of this Notice of Award. Once the Bonds have been furnished to Thornton, you will be required to execute the formal Contract via Thornton approved digital signature service.

In addition, you are requested to furnish at the same time IRS W-9 Taxpayer ID Forms and the required Certificates of Insurance and Additional Insured Endorsements evidencing compliance with the requirements for insurance stated in the Contract Documents.

The Bid Security submitted with your Bid Proposal will be retained until the Contract has been executed and the required Bonds, Insurance, and W-9 Forms have been furnished and approved.

CITY OF THORNTON, COLORADO

By: _____

Patrick Hinterberger
Contracts Supervisor

cc: SSContractsandpurchasing@ThorntonCO.gov
Contract Administration Bulletin Board
Sean Saddler, PE, Contracts and Purchasing Director

e-mail: Pete Brezall, Project Manager II

file: Zadel Reservoir Fencing, Project No. 18-554

THIS PAGE INTENTIONALLY LEFT BLANK

NOTICE TO PROCEED

Thornton, Colorado

_____, 20__

TO: [contractor name and address]

RE: NOTICE TO PROCEED – Zadel Reservoir Fencing, Project No. 18-554

You are hereby authorized to proceed with the Work within ten (10) consecutive Calendar Days from this date and substantially complete the Work within one hundred fifty (150) consecutive Calendar Days from this date. The date for Substantial Completion of this Project is _____, 20__. Liquidated Damages of one hundred dollars (\$100.00) per Calendar Day are applicable for each Calendar Day past the Substantial Completion date for which Work on this Project is not substantially complete. Other Liquidated Damages for missed milestone or other interim completion dates will apply if such dates are specified in the Contract Documents.

CITY OF THORNTON, COLORADO

BY: _____
Patrick Hinterberger
Contracts Supervisor

cc: SSContractsandpurchasing@ThorntonCO.gov

e-mail: Pete Brezall, Project Manager II

file: Zadel Reservoir Fencing, Project No. 18-554

Certificate Of Completion

Envelope Id: 78AA80CEF25C4054901F1FF9717E5EE8	Status: Completed
Subject: Complete with DocuSign: 18-554 IFB 1-11-24.pdf	
Source Envelope:	
Document Pages: 149	Signatures: 1
Certificate Pages: 1	Initials: 0
AutoNav: Disabled	Envelope Originator:
Envelope Stamping: Disabled	Patrick Hinterberger
Time Zone: (UTC-07:00) Mountain Time (US & Canada)	9500 Civic Center Drive
	Thornton, CO 80229
	Patrick.Hinterberger@ThorntonCO.gov
	IP Address: 199.117.212.4

Record Tracking

Status: Original	Holder: Patrick Hinterberger	Location: DocuSign
1/11/2024 11:25:03 AM	Patrick.Hinterberger@ThorntonCO.gov	

Signer Events

Patrick Hinterberger
 Patrick.Hinterberger@ThorntonCO.gov
 Sr. Contract Administrator
 SHI OBO City of Thornton
 Security Level: Email, Account Authentication (None)

Signature

DocuSigned by:

 6DA8F281E4154C8...
 Signature Adoption: Pre-selected Style
 Using IP Address: 199.117.212.4

Timestamp

Sent: 1/11/2024 11:26:45 AM
 Viewed: 1/11/2024 11:28:34 AM
 Signed: 1/11/2024 11:28:44 AM
 Freeform Signing

Electronic Record and Signature Disclosure:
 Not Offered via DocuSign

In Person Signer Events	Signature	Timestamp
Editor Delivery Events	Status	Timestamp
Agent Delivery Events	Status	Timestamp
Intermediary Delivery Events	Status	Timestamp
Certified Delivery Events	Status	Timestamp
Carbon Copy Events	Status	Timestamp
Witness Events	Signature	Timestamp
Notary Events	Signature	Timestamp
Envelope Summary Events	Status	Timestamps
Envelope Sent	Hashed/Encrypted	1/11/2024 11:26:45 AM
Certified Delivered	Security Checked	1/11/2024 11:28:34 AM
Signing Complete	Security Checked	1/11/2024 11:28:44 AM
Completed	Security Checked	1/11/2024 11:28:44 AM
Payment Events	Status	Timestamps